

**Organising Committee**

**Chief Patron**

Shri. KVV Satyanarayana Raju  
Chairman, Chaitanya Group

**Patrons**

Shri. K. Sasi Kiran Varma  
Vice-chairman, Chaitanya Group  
Smt. K. V. V. Lakshmi  
Executive Director, Chaitanya Group

**Co-Patrons**

Dr. D. L. N. Raju  
CEO, Chaitanya Group  
P. Subba Raju  
General Manager, GIET Institutions

**Chairperson**

Dr. T. Vamsee Kiran  
Principal, GIET Engineering College

**Convener**

Dr. B. Jagdeesh  
Head of the department,  
Department of Electronics and Communication  
Engineering  
Email: [ece.gec@giet.ac.in](mailto:ece.gec@giet.ac.in)

**Co-ordinator**

Mrs.M. Kaivalya,  
Assistant Professor,  
Department of Electronics and Communication  
Engineering  
Mobile No: 9948511155  
Email id: kaivalya044@gmail.com

**A Two Week Add on Program on  
"Hands on training on IOT"**

**REGISTRATION FORM**

1. Name of the Participant:
2. Class:
3. Roll Number:
4. Academic Year:
5. Branch:
6. Phone Number:
7. Email ID:
8. Address for Communication:
9. Signature of Participant:
10. Signature of class teacher:
11. Remarks (if any)

Date:

Station:



**Principal**  
**GIET ENGINEERING COLLEGE.**  
**NH-16, Chaitanya Knowledge City,**  
**RAJAHMUNDRY-533 296.**

HOD



**A Two Week Add on Program on  
"Hands on training on IOT"  
04.02.2021 to 17.02.2021**



**Organized**

**by**

**DEPARTMENT OF  
ELECTRONICS AND COMUNICATION  
ENGINEERING**

**GIET ENGINEERING COLLEGE**

(Formerly Known as Chaitanya Institute of Engineering & Technology)  
Approved by AICTE | Affiliated to JNTUK, Kakinada | Accredited by NAAC

**NH-16, Chaitanya Knowledge City, GIET  
Campus, Rajamahendravaram, AP.**

### About the Institute

The college is located at Chaitanya Nagar on NH-16 on the outskirts of Rajamahendravaram, in GIET campus. GIET Engineering College is an epitome of excellence in every aspect. Institute is Approved by AICTE and affiliated to JNTUK, Kakinada, Andhra Pradesh.

The Institute got accredited by NAAC. The institute offers undergraduate programs in diverse engineering streams. It features state-of-the-art facilities and a highly qualified and knowledgeable pool of staff members apart from the prescribed course curriculum, the institute offers an entire educational experience with greater exposure of students advanced skill learning via existing centres of excellence. It has been a pioneer in adopting several pedagogic innovations for the benefit of students. The achievements of the students of this institution in academics as well as placements stand testimony to the fact.



### About the Department

The department of Electronics & Communication Engineering was established in the year 2005 with an initial intake of 60 students. The undergraduate program of the department of Electronics and Communication imparts solid technical background and research capabilities among the students which help them to excel in their respective fields.

It has an array of courses for students to choose from and study such as electronics, electronic hardware and software, communications, radio and television, solid state device, microelectronics, VLSI, and other circuits & systems used in varying applications ranging from simple circuits to sophisticated digital satellite systems, GSM & CDMA technology, speech processing & computer development.

The quality teaching and guidance by highly experienced faculty members provide the best quality educational experience to the students. The regular interaction between students and faculty helps a student to apply theoretical knowledge to real-life situations. Moreover, the faculty members organize special sessions for topics such as electronics, communication, control system, networking, etc. that assures their placement in renowned multinational companies.

### About the Program

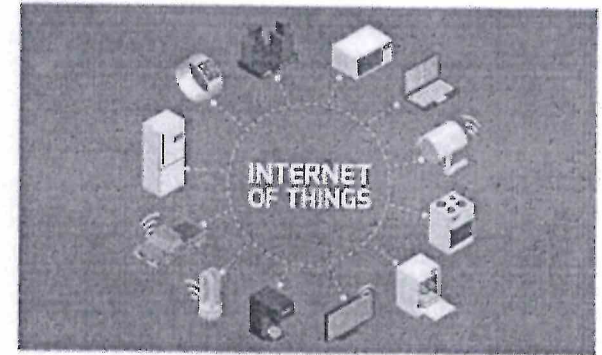

The Internet of Things (IoT) describes the network of physical objects—"things"—that are embedded with sensors, software, and other technologies for the purpose of connecting and exchanging data with other devices and systems over the internet.

Over the past few years, IoT has become one of the most important technologies of the 21st century. Now that we can connect everyday objects—kitchen appliances, cars, thermostats, baby monitors—to the internet via embedded devices, seamless communication is possible between people, processes, and things.

#### Resource Person

**Dr. B. Jagadeesh,**  
Professor ECE,  
GIET Engineering College,  
Rajahmundry.  
Mobile No: 8985305020  
Email id:bjagadeesh2020@gmail.com



## GIET ENGINEERING COLLEGE

NH - 16, Chaitanya Knowledge City, GIET Campus, Rajamahendravaram,  
Andhra Pradesh - 533296 Website: <http://www.gietec.ac.in> Email: [principalgec@giet.ac.in](mailto:principalgec@giet.ac.in)

### List of students enrolled for A Two Week Add-On Program on Hands on training on IOT

S.NO	PIN NO	NAME OF THE STUDENT	PROGRAM NAME	YEAR-SEMETER	SIGNATURE OF STUDENT
1	18MU1A0401	GADAM VENKATA LAKSHMI DEEPTHI	B.Tech-ECE	III-II	G. Deepthi
2	17T91A0450	V KAMAL JAYANTH	B.Tech-ECE	III-II	V. K-Jayanth.
3	17T91A0430	BONDADA SAI CHARAN	B.Tech-ECE	III-II	B. Sai Charan
4	17T91A0460	IRLA VENKATA THIRUMLA	B.Tech-ECE	III-II	I.V. Thirumala
5	18T91A0401	ABHISHEK KUMAR SINGH	B.Tech-ECE	III-II	Abhishek
6	18T91A0402	AKULA SHANMITHA SANDHYA DHARANI	B.Tech-ECE	III-II	A.S.S. Dharani
7	18T91A0403	ALLAMPALLI SRIHARSHA	B.Tech-ECE	III-II	A. Sriharsha
8	18T91A0404	AMUJALA GANGA BHAVANI	B.Tech-ECE	III-II	A.Ganga Bhavani
9	18T91A0405	ANYAM SRIKANTH	B.Tech-ECE	III-II	A. Srikanth
10	18T91A0406	BALINENI NAVEEN	B.Tech-ECE	III-II	B. NAVEEN
11	18T91A0407	BAVIRISETTY HEMANTH	B.Tech-ECE	III-II	B. Hemant
12	18T91A0408	BEELA RAJESH KUMAR	B.Tech-ECE	III-II	B. Rajesh Kumar
13	18T91A0410	BODDU SIVA SAI VARMA	B.Tech-ECE	III-II	B. S. Varma
14	18T91A0411	CHADHARAM MOUNIKA SUCHITRA	B.Tech-ECE	III-II	Ch. Suchitra
15	18T91A0412	CHAMAKURI LAVANYA	B.Tech-ECE	III-II	Ch. Lavanya
16	18T91A0413	CHELURI VEERA BHADRACHARYULU	B.Tech-ECE	III-II	Ch. V. B. Charyulu
17	18T91A0414	CHINTA BALAJI	B.Tech-ECE	III-II	Ch. Balaji
18	18T91A0415	TADEPALLI ANUSHA DEEPTHI	B.Tech-ECE	III-II	T. Anusha Deepthi
19	18T91A0416	DASARI SAILAJA	B.Tech-ECE	III-II	D. Sailaja
20	18T91A0417	VOOSETTI JAGADEESH	B.Tech-ECE	III-II	V. Jagadeesh
21	18T91A0418	DEVALLA VISWA SAI TEJA	B.Tech-ECE	III-II	D. V. Sai Teja
22	18T91A0419	DHENUVUKONDA VEERABABU	B.Tech-ECE	III-II	D. Veerababu
23	18T91A0420	DODDA SAI KRISHNA	B.Tech-ECE	III-II	D. S. Krishna
24	18T91A0421	EMMIDSETTI VENKAT SAI ROHIT	B.Tech-ECE	III-II	E. Rohit
25	18T91A0422	GANNI ANUSHA	B.Tech-ECE	III-II	G. Anusha
26	18T91A0423	GARAPATI MOHANA LAKSHMI SAHITHI	B.Tech-ECE	III-II	G. Sahithi
27	18T91A0424	GARAPATI SHYAMALA	B.Tech-ECE	III-II	G. Shyamala
28	18T91A0425	GINJALA RAJU	B.Tech-ECE	III-II	G. Raju
29	18T91A0426	GOKARAJU GOPI	B.Tech-ECE	III-II	G. Gopi
30	18T91A0427	GORLA RAJESH	B.Tech-ECE	III-II	G. Rajesh
31	18T91A0428	GUDALA ANNAMANI	B.Tech-ECE	III-II	G. Annamani
32	18T91A0429	GUDAPATI RATNA GOWREESHA	B.Tech-ECE	III-II	G. R. Gowreesha
33	18T91A0430	GUNDUBOGULA SAI MOULI	B.Tech-ECE	III-II	G. S. Mouli
34	18T91A0431	GUTHULA SRINJJA	B.Tech-ECE	III-II	G. Srinjja
35	18T91A0432	GUTTULA JAICHAND	B.Tech-ECE	III-II	G. Jaichand
36	18T91A0433	JAYANTHI YASASWINI	B.Tech-ECE	III-II	J. Rohith

Principal  
GIET ENGINEERING COLLEGE  
NH-16, Chaitanya Knowledge City,  
RAJAHMUNDRY-533 296.

37	18T91A0434	JUJJAVARAPU BHAVANA	B.Tech-ECE	III-II	J Bhavana
38	18T91A0435	KALISETTI SOMASEKHAR	B.Tech-ECE	III-II	K. Soma Sekhar
39	18T91A0436	KALLEPALLI AKHILA	B.Tech-ECE	III-II	K. Akhila
40	18T91A0437	KAMBALA SIVA KAVYA	B.Tech-ECE	III-II	K. S. Kavya
41	18T91A0438	KAMIREDDY VEERA JHANSI	B.Tech-ECE	III-II	K. Veera Jhansi
42	18T91A0439	KANDIPAPPU MAHA LAKSHMI	B.Tech-ECE	III-II	K.M. Lakshmi
43	18T91A0440	KARRI SRI RAMA KRISHNA	B.Tech-ECE	III-II	K. Sri Ramakrishna
44	18T91A0441	KATTA JAYA SAI PRAKASH	B.Tech-ECE	III-II	K. S.S. Prakash
45	18T91A0442	KATTA RAMBABU	B.Tech-ECE	III-II	K. Ram Babu
46	18T91A0443	KAVETI DURGA SHYAM SIVA PRASAD	B.Tech-ECE	III-II	K. Shyam
47	18T91A0444	KOLAGANTI SRIDHAR	B.Tech-ECE	III-II	K. Sridhar
48	18T91A0445	KONATHALA HARITHA DEVI	B.Tech-ECE	III-II	K. Haritha Devi
49	18T91A0446	KOTHAPALLI BALA VEERENDRA	B.Tech-ECE	III-II	K. Bala Veerendra
50	18T91A0447	KOTHAPALLI VISHNU SHIVANI	B.Tech-ECE	III-II	K. V. Shivani
51	18T91A0448	LELLA JOSHI BHASKAR	B.Tech-ECE	III-II	L. Joshi
52	18T91A0449	LOLABHATTU RENUKA BHAGYA LAKSHMI	B.Tech-ECE	III-II	L. Renuka Bhagya Lakshmi
53	18T91A0450	MAJJI KRISHNAJA	B.Tech-ECE	III-II	M. Krishnaja
54	18T91A0451	MAJJI SUREKHA	B.Tech-ECE	III-II	M. Surekha
55	18T91A0452	MANCHEM SAHITHI	B.Tech-ECE	III-II	M. Sahithi
56	18T91A0453	MEDAPATI MOURYA REDDY	B.Tech-ECE	III-II	M. Mourya
57	18T91A0454	MEKA SRIRAM	B.Tech-ECE	III-II	M. Sriram
58	18T91A0455	MOUNIKA DASARI	B.Tech-ECE	III-II	Mounika
59	18T91A0456	MOYILLA SURYA CHAKRAPAVANI	B.Tech-ECE	III-II	M. S. Ch. Pavani
60	18T91A0457	MUDDA SATYA MANIKANTA	B.Tech-ECE	III-II	M. S. Manikanta Raja
61	18T91A0458	MULLAPUDI BHARGAVI	B.Tech-ECE	III-II	Bhargavi
62	18T91A0459	NALLA YAMINI SRILATHA	B.Tech-ECE	III-II	N. Yamini
63	18T91A0460	NAMALA DEEPTIKA DEVI	B.Tech-ECE	III-II	N. Deepthika Devi
64	18T91A0461	NANEPALLI CHANDRA SEKHAR	B.Tech-ECE	III-II	N. Chandra Sekhar
65	18T91A0462	NARIKAT VARSHA VIHARI	B.Tech-ECE	III-II	N. Varsha Vihari
66	18T91A0463	NIMMAGADDA DEEPTHI	B.Tech-ECE	III-II	N. Deepthi
67	18T91A0464	NIMMAGADDA KASI ANNAPURNA	B.Tech-ECE	III-II	N. K. Annapurna
68	18T91A0465	NIMMALA SIVA RAMA KRISHNA SAI PRASAD	B.Tech-ECE	III-II	N. S. R. K. Prasad
69	18T91A0466	PALANKI SRISAIKRISHNA	B.Tech-ECE	III-II	P. Sai
70	18T91A0468	PARASA NAGA SAI TEJA	B.Tech-ECE	III-II	P. Naga Sai Tej
71	18T91A0469	PEDAPUDI SANDHYA RANI	B.Tech-ECE	III-II	Sandhya
72	18T91A0470	PEDDIRAJU SAI SRAVYESH	B.Tech-ECE	III-II	P. S. Sravyesh
73	18T91A0471	PENDYALA SIDDARTH	B.Tech-ECE	III-II	P. Siddharth
74	18T91A0472	PERUGU MAHESH	B.Tech-ECE	III-II	P. Mahesh
75	18T91A0474	PURETI SRIDEVI	B.Tech-ECE	III-II	P. Sridevi
76	18T91A0475	PYLA SAI DURGA PRASAD	B.Tech-ECE	III-II	P. Sai
77	18T91A0477	SANGISETTI SURYA SRI NAGALAKSHMI	B.Tech-ECE	III-II	S. Nagalakshmi
78	18T91A0478	SANGULA LAKSHMI SOWJANYA	B.Tech-ECE	III-II	S. Sowjanya
79	18T91A0479	SATYAM ROSHINI VENKATA NEERAJA	B.Tech-ECE	III-II	S. Roshini
80	18T91A0480	YALAMATI DEVIKA	B.Tech-ECE	III-II	Y. Devika
81	18T91A0481	SIGATAPU SURYA PRASANNA	B.Tech-ECE	III-II	S. S. Prasanna

Principal  
GIET ENGINEERING COLLEGE,  
NH-16, Chaitanya Knowledge City,  
RAJAHMUNDRY-533 296.

82	18T91A0482	SIRRA RAKESH	B.Tech-ECE	III-II	S. Rakesh
83	18T91A0483	SONTEM NAGESWARA RAO	B.Tech-ECE	III-II	S. Nageswara Rao
84	18T91A0484	SRIREDDY VENKATA VIGNESH	B.Tech-ECE	III-II	S. Vignesh
85	18T91A0485	SYED GHOUSIA BEGUM	B.Tech-ECE	III-II	Syed Gaus
86	18T91A0486	SYED SIDDIQ HUSSAIN	B.Tech-ECE	III-II	S. Siddiq Hussain
87	18T91A0487	YALLA ANAND DURGA SAGAR	B.Tech-ECE	III-II	Y. Anand Durga
88	18T91A0488	TADI SATISH	B.Tech-ECE	III-II	T. Satish
89	18T91A0489	TALLAPUDI PUSHPA LATHA	B.Tech-ECE	III-II	T. Pushpa Latha
90	18T91A0491	TEKETI YASASWINI	B.Tech-ECE	III-II	T. yasaswini
91	18T91A0492	TIRNATI GIREESH NAIDU	B.Tech-ECE	III-II	T. Gireesh Naidu
92	19T95A0401	BATTU JAPHANYA PRASANNA KUMAR	B.Tech-ECE	III-II	B. S. P Kumar
93	19T95A0402	CH SAI PRASANTH	B.Tech-ECE	III-II	K. Naga harika
94	19T95A0403	KURMADASU NAGA HARITHA	B.Tech-ECE	III-II	K. Naga Harika
95	19T95A0404	MUMMIDI SAI KUMAR	B.Tech-ECE	III-II	M. Saikumar
96	19T95A0405	PANDRINKI MADHAVI LATHA	B.Tech-ECE	III-II	P. madhavi Latha
97	19T95A0406	PENTAGATLA SUMA DEVI	B.Tech-ECE	III-II	P. Suma Devi
98	19T95A0407	PIKKILI KAMESWARI	B.Tech-ECE	III-II	P. kameswari
99	19T95A0408	RAMBARIKELA AVINASH	B.Tech-ECE	III-II	R. Avinash
100	19T95A0409	REKAMANDI DURGA DEVI	B.Tech-ECE	III-II	R. Durga devi
101	19T95A0410	SINGIREDDY ALEKHYA	B.Tech-ECE	III-II	S. Alekhya
102	19T95A0411	GIDUTHURI SAI SAMBA SIVA	B.Tech-ECE	III-II	G. Sai Siva

*M. Kalug*  
Program Coordinator

*Principal*  
Principal  
GIET ENGINEERING COLLEGE,  
NH-16, Chaitanya Knowledge City,  
RAJAHMUNDRY - 533 296.

*HOD*  
HOD



## GIET ENGINEERING COLLEGE

NH-16, Chaitanya Knowledge City, GIET Campus, Rajamahendravaram.  
 Andhra Pradesh - 533296 Website: <http://www.gietec.ac.in> Email: [principalgect@giet.ac.in](mailto:principalgect@giet.ac.in)

### DEPARTMENT OF ELECTRONICS AND COMMUNICATIONS ENGINEERING

#### Day wise Attendance

S.NO	PIN NO	NAME OF THE STUDENT	04.02.2021	05.02.2021	06.02.2021	08.02.2021	09.02.2021	10.02.2021	11.02.2021	12.02.2021	13.02.2021	15.02.2021	16.02.2021	17.02.2021
1	18MU1A0401	GADAM VENKATA LAKSHMI DEEPTHI	P	P	P	P	P	P	P	P	P	P	P	P
2	17T91A0450	V KAMAL JAYANTH	P	P	P	A	P	P	P	P	P	P	P	P
3	17T91A0430	BONDADA SAI CHARAN	P	P	P	P	P	P	P	P	P	P	P	P
4	17T91A0460	IRLA VENKATA THIRUMLA	P	P	P	P	P	P	P	P	P	P	P	P
5	18T91A0401	ABHISHEK KUMAR SINGH	P	A	P	P	P	P	P	P	P	P	P	P
6	18T91A0402	AKULA SHANMITHA SANDHYA DHARANI	P	P	P	P	P	A	P	P	P	P	P	P
7	18T91A0403	ALLAMPALLI SRIHARSHA	A	P	P	P	P	P	P	P	P	P	P	P
8	18T91A0404	AMUJALA GANGA BHAVANI	P	P	P	P	A	P	P	P	P	P	P	P
9	18T91A0405	ANYAM SRIKANTH	P	P	A	P	P	P	A	P	P	P	P	P
10	18T91A0406	BALINENI NAVEEN	P	P	P	P	P	P	P	A	P	P	P	P
11	18T91A0407	BAVIRISETTY HEMANTH	P	A	P	P	P	P	P	P	P	P	P	P
12	18T91A0408	BEELA RAJESH KUMAR	P	P	P	A	P	P	P	P	P	P	P	P
13	18T91A0410	BODDU SIVA SAI VARMA	P	P	P	P	P	P	P	P	P	P	P	P
14	18T91A0411	CHADHARAM MOUNIKA SUCHITRA	P	P	P	P	P	P	P	P	P	P	P	P
15	18T91A0412	CHAMAKURI LAVANYA	A	P	P	P	A	P	P	P	P	P	P	P
16	18T91A0413	CHELLURI VEERA BHADRACHARYULU	P	P	P	P	P	P	P	P	P	P	P	P
17	18T91A0414	CHINTA BALAJI	P	P	P	P	P	P	P	P	P	P	P	P
18	18T91A0415	TADEPALLI ANUSHA DEEPTHI	P	P	P	P	P	P	P	P	P	P	P	P
19	18T91A0416	DASARI SAILAJA	P	P	A	P	P	P	P	P	P	P	P	P
20	18T91A0417	VOOSETTI JAGADEESH	P	P	P	P	P	P	A	P	P	P	P	P
21	18T91A0418	DEVALLA VISWA SAI TEJA	P	A	P	P	P	P	P	P	P	P	P	P
22	18T91A0419	DHENUVUKONDA VEERABABU	P	P	P	P	P	P	P	P	P	P	P	P
23	18T91A0420	DODDA SAI KRISHNA	P	P	P	P	P	A	P	P	P	P	P	P
24	18T91A0421	EMMIDSETTY VENKAT SAI ROHIT	P	P	P	P	P	P	P	A	P	P	P	P
25	18T91A0422	GANNI ANUSHA	P	P	P	P	P	P	P	P	P	P	P	P
26	18T91A0423	GARAPATI MOHANA LAKSHMI SAHITHI	P	P	P	P	P	P	P	P	P	P	P	P
27	18T91A0424	GARAPATI SHYAMALA	P	P	P	P	P	P	P	P	P	P	P	P
28	18T91A0425	GINJALA RAJU	P	P	P	P	P	P	P	P	P	P	P	P
29	18T91A0426	GOKARAJU GOPI	P	P	P	P	P	P	P	P	P	P	P	P

Principal  
 GIET ENGINEERING COLLEGE,  
 NH-16, Chaitanya Knowledge City,  
 RAJAHMUNDRY-533296







			P	P	A	P	P	P	A	P	P	P	P	P
53	18T91A0549	VANA SAI SNEHA CHAND	P	P	P	P	P	P	P	P	P	P	P	P
54	18T91A0550	VANA SAI SUDHA CHAND	P	A	P	P	A	P	P	A	P	A	P	P
55	18T91A0551	VENIGALLA CHANDANA	P	P	P	P	P	P	P	P	P	P	P	P
56	18T91A0552	YALAMATI PURNA LAVANYA	P	P	A	P	P	A	A	P	P	P	P	P
57	18T91A0553	YARRAMSETTI SATTI RAJU	P	P	P	P	P	P	P	P	P	P	P	P
58	19T95A0501	P HARI MANIKANTHA SIVA PRASAD	P	A	P	P	P	P	P	P	P	A	P	P

*Anchare*  
Coordinator

*[Signature]*

Principal

GIET ENGINEERING COLLEGE,  
NH-16, Chaitanya Knowledge City,  
RAJAHMUNDRY - 533 296.

*[Signature]*  
HOD



# GIET ENGINEERING COLLEGE

NH - 16, Chaitanya Knowledge City, GIET Campus, Rajamahendravaram,  
Andhra Pradesh - 533296 Website: <http://www.gietec.ac.in> Email: [principalgec@giet.ac.in](mailto:principalgec@giet.ac.in)

---

Date: 20.02.2021

## PROGRAM REPORT

**Name of the Event:** A Two Week Add-On Program –“Hands on training on IOT”

**Date:** 04.02.2021 to 17.02.2021

**Resource Person:** Dr.B.Jagadeesh

Professor ECE, Godavari institute of engineering and technology

**Email.id:** [bjagadeesh2020@gmail.com](mailto:bjagadeesh2020@gmail.com)

**Contact number:** 8985305020

**Name of the Coordinator:** Mr.M.Kaivalya

**Number of students attended:** 102

**Venue:** Computer lab, CV Raman block, GIET Engineering college

### **Objectives of the Program:**

- To Explore the Knowledge to the students IoT on programming.
- To provide a working knowledge with Embedded C and Raspberry pi.
- To Implement the Real time applications using IoT

**Topics to be covered:**

  
Principal  
GIET ENGINEERING COLLEGE,  
NH-16, Chaitanya Knowledge City,  
RAJAHMUNDRY-533 296.

- Introduction to internet of things, Architecture and design
- Concepts of Arduino, Raspberry pi, Embedded C
- To implement Real time applications

**Outcomes of the Program:**

- At the end of this course, the student will be able to
1. Learn the internet of things and its applications
  2. Setup IOT connectivity using programming language
  3. Understand architecture and programming

  
Coordinator

  
Principal  
GIET ENGINEERING COLLEGE,  
NH-16, Chaitanya Knowledge City,  
RAJAHMUNDRY - 533 296.

  
HOD-ECE



# GIET ENGINEERING COLLEGE

Approved by AICTE, New Delhi/Affiliated to JNTUK, Kakinada/Accredited by NAAC  
NH-16, Chaitanya Knowledge City, GIET Campus, Rajamahendravaram-533296, AP, India.  
Phone: 96529 29111, Website: [www.gietec.ac.in](http://www.gietec.ac.in), Email: [principalgec@giet.ac.in](mailto:principalgec@giet.ac.in)

## CERTIFICATE

Certified that Mr./Ms. Ch. Lavanya

bearing the PIN 18T91A0412 studying III - II B.Tech./MBA in the

department of ECE has attended the add-on/certificate course on

Hands on training on IOT from 04-02-2021 to

17-02-2021 during the academic year 2020-21. He/ She is advised to

maintain the same spirit in his/her future endeavors.

  
Coordinator

  
HOD

  
Principal  
GIET ENGINEERING COLLEGE,  
NH-16, Chaitanya Knowledge City,  
RAJAHMUNDRY-533 296.

  
Principal



# GIET ENGINEERING COLLEGE

Approved by AICTE, New Delhi/Affiliated to JNTUK, Kakinada/Accredited by NAAC  
NH-16, Chaitanya Knowledge City, GIET Campus, Rajamahendravaram-533296, AP, India.  
Phone: 96529 29111, Website: [www.gietec.ac.in](http://www.gietec.ac.in), Email: [principalgec@giet.ac.in](mailto:principalgec@giet.ac.in)

## CERTIFICATE

Certified that Mr./Ms. Abhishek kumar Singh

bearing the PIN 18T91A0401 studying III - II B.Tech./MBA in the

department of ECE has attended the add-on/certificate course on

Hands on training on IOT from 04-02-2021 to

17-02-2021 during the academic year 2020-21. He/ She is advised to

maintain the same spirit in his/her future endeavors.

M. Kaindy  
Coordinator

H. Jeyu  
HOD

Principal  
Principal  
GIET ENGINEERING COLLEGE,  
NH-16, Chaitanya Knowledge City,  
RAJAHMUNDRY-533 296.

Principal  
Principal



# GIET ENGINEERING COLLEGE

Approved by AICTE, New Delhi/Affiliated to JNTUK, Kakinada/Accredited by NAAC  
NH-16, Chaitanya Knowledge City, GIET Campus, Rajamahendravaram-533296, AP, India.  
Phone: 96529 29111, Website: [www.gietec.ac.in](http://www.gietec.ac.in), Email: [principalgec@giet.ac.in](mailto:principalgec@giet.ac.in)

## CERTIFICATE

Certified that Mr./Ms. D. Veerababu

bearing the PIN 18T91A0419 studying III-II B.Tech./MBA in the  
department of ECE has attended the add-on/certificate course on

Hands on training on IOT from 04-02-2021 to  
17-02-2021 during the academic year 2020-21. He/ She is advised to

maintain the same spirit in his/her future endeavors.

M. Calvalya  
Coordinator

A. Jayaram  
HOD

[Signature]  
Principal  
GIET ENGINEERING COLLEGE,  
NH-16, Chaitanya Knowledge City,  
RAJAHMUNDRY-533 296.

[Signature]  
Principal



# GIET ENGINEERING COLLEGE

Approved by AICTE, New Delhi/Affiliated to JNTUK, Kakinada/Accredited by NAAC  
NH-16, Chaitanya Knowledge City, GIET Campus, Rajamahendravaram-533296, AP, India.  
Phone: 96529 29111, Website: [www.gietec.ac.in](http://www.gietec.ac.in), Email: [principalgec@giet.ac.in](mailto:principalgec@giet.ac.in)

## CERTIFICATE

Certified that Mr./Ms. D. Mounika

bearing the PIN 18T91A0455 studying III - II B.Tech./ MBA in the

department of ECE has attended the add-on/certificate course on

Hands on training on IOT from 04-02-2021 to

17-02-2021 during the academic year 2020-21. He/ She is advised to

maintain the same spirit in his/her future endeavors.

  
Coordinator

  
HOD

  
Principal  
GIET ENGINEERING COLLEGE,  
NH-16, Chaitanya Knowledge City,  
RAJAHMUNDRY-533 296.

  
Principal



# GIET ENGINEERING COLLEGE

Approved by AICTE, New Delhi/Affiliated to JNTUK, Kakinada/Accredited by NAAC  
NH-16, Chaitanya Knowledge City, GIET Campus, Rajamahendravaram-533296, AP, India.  
Phone: 96529 29111, Website: [www.gietec.ac.in](http://www.gietec.ac.in), Email: [principalgec@giet.ac.in](mailto:principalgec@giet.ac.in)

## CERTIFICATE

Certified that Mr./Ms. T. Yasaswini

bearing the PIN 18791A0491 studying III - II B.Tech./ MBA in the

department of ECE has attended the add-on/certificate course on

Hands on training on IoT from 04-02-2021 to

17-02-2021 during the academic year 2020-21. He/ She is advised to

maintain the same spirit in his/her future endeavors.

M. Caralya  
Coordinator

A. J. Gu  
HOD

Principal  
Principal  
GIET ENGINEERING COLLEGE, Principal  
NH-16, Chaitanya Knowledge City,  
RAJAHMUNDY-533 296.



## Organising Committee

### Chief Patron

Shri. KVV Satyanarayana Raju  
Chairman, Chaitanya Group

### Patrons

Shri. K. Sasi Kiran Varma  
Vice-chairman, Chaitanya Group  
Smt. K. V. V. Lakshmi  
Executive Director, Chaitanya Group

### Co-Patrons

Dr. D. L. N. Raju  
CEO, Chaitanya Group  
P. Subba Raju  
General Manager, GIET Institutions

### Chairperson

Dr. T. Vamsee Kiran  
Principal, GIET Engineering College

### Convener

Mr. K. Nagaraju,  
Head of the department,  
Department of CSE  
Mobile No: 9989442311  
Email: [nagaraju@giet.ac.in](mailto:nagaraju@giet.ac.in)

### Co-ordinator

Mrs. Archana,  
Assistant Professor,  
Department of CSE  
Mobile No: 9030659795  
Email id: [archanacse@giet.ac.in](mailto:archanacse@giet.ac.in)

## A Two Week Add on Program on “.NET Framework Programming” REGISTRATION FORM

1. Name of the Participant:
2. Class:
3. Roll Number:
4. Academic Year:
5. Branch:
6. Phone Number:
7. Email ID:
8. Address for Communication:
9. Signature of Participant:
10. Signature of class teacher:
11. Remarks (if any)

Date:  
Station:

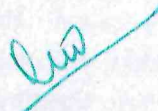
  
Principal  
GIET ENGINEERING COLLEGE,  
NH-16, Chaitanya Knowledge City,  
RAJAHMUNDRY-533 296.

HOD



A Two Week Add on Program on  
“.NET Framework Programming”  
05.02.2021 to 18.02.2021



Organized  
by  
DEPARTMENT OF  
COMPUTER SCIENCE AND ENGINEERING  
**GIET ENGINEERING COLLEGE**  
(Formerly Known as Chaitanya Institute of Engineering & Technology)  
Approved by AICTE | Affiliated to JNTUK, Kakinada | Accredited by NAAC

NH-16, Chaitanya Knowledge City, GIET  
Campus, Rajamahendravaram, AP.

### About the Institute

The college is located at Chaitanya Nagar on NH-16 on the outskirts of Rajamahendravaram, in GIET campus. GIET Engineering College is an epitome of excellence in every aspect. Institute is Approved by AICTE and affiliated to JNTUK, Kakinada, Andhra Pradesh.

The Institute got accredited by NAAC. The institute offers undergraduate programs in diverse engineering streams. It features state-of-the-art facilities and a highly qualified and knowledgeable pool of staff members. apart from the prescribed course curriculum, the institute offers an entire educational experience with greater exposure of students advanced skill learning via existing centres of excellence. It has been a pioneer in adopting several pedagogic innovations for the benefit of students. The achievements of the students of this institution in academics as well as placements stand testimony to the fact.



### About the Department

Department of COMPUTER SCIENCE AND ENGINEERING started in the year of 2005. It is offering graduate program B.Tech. Department has well qualified and dedicated faculty members.

Department has produced good number of graduates well settled in industry and some are also involved in research activities.

The Department provides state-of-the-art computing facilities to the students enabling them to stay a step ahead. The courses are designed to combine rigorous academic study and exhaustive practical exposure for students with in-depth lab-oriented courses, projects, and internships.

The Department hosts a number of workshops and student managed symposiums. The department also encourages innovative projects and Internships in various interrelated domains. The department has high-end computer labs as well as the CM Skill Excellence Centre. Because the current industry requires a student with exposure and skill set in Data Sciences, Machine Learning, Web Development, and so on, the department-driven programme is designed to prepare students for the workforce.

### About the Program



The Microsoft-created .NET Framework is a software development framework that offers a runtime environment, a collection of libraries, and a range of tools for creating and running applications on Windows-based operating systems. The framework supports a range of application types, including desktop, web, mobile, and a number of programming languages, including C#, F#, and Visual Basic.

The Common Language Runtime (CLR) and the .NET Framework Class Library are the two primary parts of the .NET Framework. While the class library offers a substantial collection of pre-built functions and classes that may be used to develop a wide range of applications

#### Resource Person

**Mr. Y. Durga Prasad,**  
Assistant Professor, CSE  
GIET Engineering College,  
Rajahmundry.  
Mobile No: 9745326713  
Email: [dprasadcse@giet.ac.in](mailto:dprasadcse@giet.ac.in)



## GIET ENGINEERING COLLEGE

NH - 16, Chaitanya Knowledge City, GIET Campus, Rajamahendravaram,  
Andhra Pradesh - 533296 Website: <http://www.gietec.ac.in> Email: [principalgco@giet.ac.in](mailto:principalgco@giet.ac.in)

### List of students enrolled for Add-on Certificate Program on .Net Framework Programming

S.NO	PIN NO	NAME OF THE STUDENT	PROGRAM NAME	YEAR-SEMETER	SIGNATURE OF STUDENT
1	17T91A0523	ANUMANCHIPALLI K S SRINIVAS	B.Tech-CSE	III-II	A.K.S. SRINIVAS
2	18MU1A0505	DANDAMOUDI YASWINI	B.Tech-CSE	III-II	D. Yaswini
3	18MU1A0506	DANDAMUDI MALATHY	B.Tech-CSE	III-II	D. Malathy
4	18MU1A0508	GANNAMANI JYOTSNA SRIJA	B.Tech-CSE	III-II	N. Ch. S. Srinivas
5	18MU1A0513	SUNKARA SIREESHA	B.Tech-CSE	III-II	S. Sireesha
6	18MU1A0520	EMANI NAGA SRINJA	B.Tech-CSE	III-II	E. Sri Nija
7	18MU1A0521	JALAGAM NAMRATHA RATNAM	B.Tech-CSE	III-II	J. Ratnam
8	18MU1A0522	KUNKATLA SRI LAKSHMI	B.Tech-CSE	III-II	K. Sri Lakshmi
9	18MU1A0523	SATYA SRI MALLULA	B.Tech-CSE	III-II	M. S. Satya
10	18MU1A0524	MUPPIDI ANUDEEP REDDY	B.Tech-CSE	III-II	A. Anudeep
11	18MU1A0525	S C NAGA SRI SATYASAI SUDHEER	B.Tech-CSE	III-II	S. Sai Mellud
12	18T91A0501	GOLLU RUCHITHA	B.Tech-CSE	III-II	R. Ruchitha
13	18T91A0503	AINAMPUDI DIVYA SRI	B.Tech-CSE	III-II	A. Divya
14	18T91A0504	ANNADEVARA SRIVALLI	B.Tech-CSE	III-II	A. Srivalli
15	18T91A0505	A NAGA DURGA SATYA MANIKANTA	B.Tech-CSE	III-II	A. Durga
16	18T91A0506	B GOWRI SHANKAR NAGA BABU	B.Tech-CSE	III-II	B. Naga Babu
17	18T91A0507	BADDILA NAGA LAVANYA	B.Tech-CSE	III-II	B. Lavanya
18	18T91A0508	BALABHADRUNI SOWMYA	B.Tech-CSE	III-II	B. Sowmya
19	18T91A0509	BATTULA SOWMYA	B.Tech-CSE	III-II	B. Sowmya
20	18T91A0510	BIRRE GANGADHAR	B.Tech-CSE	III-II	B. Gandhar
21	18T91A0511	BOTTU THANMAYI	B.Tech-CSE	III-II	B. Thanmayi
22	18T91A0512	BUSIREDDY HEMANTH	B.Tech-CSE	III-II	B. Hemant
23	18T91A0513	DEVALLA KOMAL KIRAN	B.Tech-CSE	III-II	D. Komal Kiran
24	18T91A0514	DONGA MOHAN SATYA SAI	B.Tech-CSE	III-II	D. Satya Sai
25	18T91A0515	DULAM RUPA SREE NAGESH	B.Tech-CSE	III-II	D. R. S. Nagesh
26	18T91A0516	YERRAMSETTI RAMYA SRI	B.Tech-CSE	III-II	Y. Ramya
27	18T91A0517	GOPAVARAPU SUSHMITHA	B.Tech-CSE	III-II	G. Sushmitha
28	18T91A0518	GUTTA APARANJI	B.Tech-CSE	III-II	G. Aparanji
29	18T91A0519	INJETI JYOTHIBABU	B.Tech-CSE	III-II	I. Jyothi
30	18T91A0521	JONNALAGADDA GANESH	B.Tech-CSE	III-II	J. Ganesh
31	18T91A0522	KODAVATI RAKESH	B.Tech-CSE	III-II	K. Rakesh
32	18T91A0523	KOTHALA SAI CHARAN	B.Tech-CSE	III-II	K. Sai Charan
33	18T91A0524	KUSU GOWRI PRASANNA	B.Tech-CSE	III-II	K. Gowri Prasanna
34	18T91A0525	LAKKISETTI BHAVANIDEVI	B.Tech-CSE	III-II	L. Bhavanidevi
35	18T91A0526	MATHI DYVA ASHEERVADA RAJU	B.Tech-CSE	III-II	M. Raju
36	18T91A0527	MARGANA RISHITHA	B.Tech-CSE	III-II	M. Rishitha
37	18T91A0528	M VEERA SIVA MANIKANTA	B.Tech-CSE	III-II	M. Manikanta
38	18T91A0529	M N VENKATA KRISHNA TEJA	B.Tech-CSE	III-II	M. Teja
39	18T91A0531	MUKKU HANISHA	B.Tech-CSE	III-II	M. Hanisha

Principal  
GIET ENGINEERING COLLEGE,  
NH-16, Chaitanya Knowledge City,  
RAJAHMUNDRY-533 296.

40	18T91A0534	PALATHOTI JESSY CYRUS	B.Tech-CSE	III-II	Jessy Cyrus
41	18T91A0535	PALINGI AJAY	B.Tech-CSE	III-II	P. Ajay
42	18T91A0536	PALIVELA JASHNAVI	B.Tech-CSE	III-II	P. JASHNAVI
43	18T91A0537	KAVYA DEVADA	B.Tech-CSE	III-II	Kavya Devada
44	18T91A0538	PALLA GANGA BHAVANI	B.Tech-CSE	III-II	Bhavani
45	18T91A0539	PALLA SIVA RAMA KRISHNA	B.Tech-CSE	III-II	Krishna
46	18T91A0540	PAVANI MATAPARTHI	B.Tech-CSE	III-II	Mataparthi
47	18T91A0542	RAGHAVA SINGH JAHNAVI	B.Tech-CSE	III-II	Jahnavi
48	18T91A0543	R S MANI SAICHANDRA MAHESH	B.Tech-CSE	III-II	Mahesh
49	18T91A0544	SETTI NEELESH KUMAR	B.Tech-CSE	III-II	Kumar
50	18T91A0545	SINGAVARAPU ISHWARYA	B.Tech-CSE	III-II	Ishwarya
51	18T91A0547	SURAMPUDI VANI	B.Tech-CSE	III-II	Vani
52	18T91A0548	UNDAMATLA PATTABHIRAM	B.Tech-CSE	III-II	Pattabhiram
53	18T91A0549	VANA SAI SNEHA CHAND	B.Tech-CSE	III-II	Sneha Chand
54	18T91A0550	VANA SAI SUDHA CHAND	B.Tech-CSE	III-II	Sudha Chand
55	18T91A0551	VENIGALLA CHANDANA	B.Tech-CSE	III-II	Chandana
56	18T91A0552	YALAMATI PURNA LAVANYA	B.Tech-CSE	III-II	Lavanya
	18T91A0553	YARRAMSETTI SATTI RAJU	B.Tech-CSE	III-II	Satti Raju
58	19T95A0501	P HARI MANIKANTHA SIVA PRASAD	B.Tech-CSE	III-II	Siva Prasad

Achane  
COORDINATOR

Principal

HOD

GIET ENGINEERING COLLEGE,  
NH-16, Chaitanya Knowledge City,  
RAJAHMUNDRY - 533 296.



2020-21  
07-02-2021

**GIET ENGINEERING COLLEGE**  
NH - 16, Chaitanya Knowledge City, GIET Campus, Rajamahendravaram,  
Andhra Pradesh - 533296 Website: <http://www.gietec.ac.in> Email: [principalgccc@giet.ac.in](mailto:principalgccc@giet.ac.in)

**DEPARTMENT OF COMPUTER SCIENCE AND ENGINEERING**

**Day wise attendance**

S.NO	PIN NO	NAME OF THE STUDENT	05.02.2021	06.02.2021	08.02.2021	09.02.2021	10.02.2021	11.02.2021	12.02.2021	13.02.2021	15.02.2021	16.02.2021	17.02.2021	18.02.2021
1	17T91A0523	ANUMANCHIPALLI K S SRINIVAS	P	A	P	P	P	P	P	P	P	P	P	P
2	18MU1A0505	DANDAMOODI YASWINI	P	P	P	P	P	P	P	P	P	P	P	P
3	18MU1A0506	DANDAMUDI MALATHY	P	P	P	P	P	P	A	P	P	P	P	P
4	18MU1A0508	GANNAMANI JYOTSNA SRIJA	P	A	P	P	P	P	P	P	P	P	P	P
5	18MU1A0513	SUNKARA SIREESHA	P	P	P	P	P	A	P	P	P	P	P	P
6	18MU1A0520	EMANI NAGA SRINIJA	P	P	P	P	P	P	P	P	P	P	P	P
7	18MU1A0521	JALAGAM NAMRATHA RATNAM	P	P	P	P	P	P	P	P	A	P	P	P
8	18MU1A0522	KUNKATLA SRI LAKSHMI	P	P	A	P	P	P	P	P	P	P	P	P
9	18MU1A0523	SATYA SRI MALLULA	P	P	P	P	P	P	A	P	P	A	P	P
10	18MU1A0524	MUPPIDI ANUDEEP REDDY	P	P	P	P	P	P	P	P	P	P	P	P
11	18MU1A0525	SRIMANTHULA C NAGA SRI SATYASAI SUDHEER	P	P	A	P	P	P	P	P	P	P	P	P
12	18T91A0501	GOLLU RUCHITHA	P	P	P	P	P	P	P	P	P	P	A	P
13	18T91A0503	AINAMPUDI DIVYA SRI	P	P	P	P	P	P	P	P	P	P	P	P
14	18T91A0504	ANNADEVARA SRIVALLI	P	A	P	P	P	P	A	P	P	P	P	P
15	18T91A0505	ARAVA NAGA DURGA SATYA MANIKANTA	P	P	P	A	P	P	P	A	P	P	P	P
16	18T91A0506	BADANALA GOWDAR SHANKAR NAGA BABU	P	P	P	P	P	P	P	P	P	P	P	P
17	18T91A0507	BADDILA NAGA JAYANTHA	P	A	P	P	P	P	P	P	P	P	P	P
18	18T91A0508	BALAJI HADRUNI SOWMYA	P	P	P	P	P	P	P	A	P	P	P	P
19	18T91A0509	BATTULA SOWMYA	P	P	P	A	P	P	P	P	P	P	P	P
20	18T91A0510	BIRRE GANGADHAR	P	P	P	P	P	P	P	P	P	P	P	P
21	18T91A0511	BOTTU THANMAYI	P	P	A	P	P	P	P	P	P	P	P	A
22	18T91A0512	BUSIREDDY HEMANTH	P	P	P	P	P	P	P	P	P	P	P	P

24	18T91A0514	DONGA MOHAN SATYA SAI	A	P	P	P	P	P	P	A	P	P	P	P	P
25	18T91A0515	DULAM RUPA SREE NAGESH	P	P	A	P	P	P	P	P	P	A	P	P	P
26	18T91A0516	YERRAMSETTI RAMYA SRI	P	P	P	P	A	P	P	A	P	P	P	P	P
27	18T91A0517	GOPAVARAPU SUSHMITHA	P	A	P	P	P	A	P	P	A	P	P	P	A
28	18T91A0518	GUTTA APARANJI	P	P	P	P	P	P	P	P	P	P	P	P	P
29	18T91A0519	INJETI JYOTHIBABU	P	P	A	P	P	P	P	P	P	P	P	P	P
30	18T91A0521	JONNALAGADDA GANESH	P	P	P	P	P	P	P	A	P	P	P	P	P
31	18T91A0522	KODAVATI RAKESH	P	P	P	P	P	P	P	P	P	P	P	P	P
32	18T91A0523	KOTHALA SAI CHARAN	P	P	P	A	P	P	P	P	A	P	P	P	P
33	18T91A0524	KUSU GOWRI PRASANNA	P	P	P	P	P	P	P	P	P	P	P	P	P
34	18T91A0525	LAKKISETTI BHAVANIDEVI	P	A	P	P	P	P	P	P	P	P	P	P	P
35	18T91A0526	MATHI DYVA ASHEERVADA RAJU	P	P	P	P	P	P	P	A	P	P	A	P	P
36	18T91A0527	MARGANA RISHITHA	P	P	P	P	P	P	P	P	P	P	P	P	P
37	18T91A0528	MARUKURTHI VEERA SIVA MANIKANTA	P	P	A	P	P	P	P	P	P	P	P	P	P
38	18T91A0529	MEKA LAKSHMI NARASIMHA VENKATA KRISHNA TEJA	P	P	P	P	P	A	P	P	P	P	A	P	P
39	18T91A0531	MUKKU HANISHA	P	P	P	P	P	P	P	P	P	P	P	P	P
40	18T91A0534	PALATHOTI JESSY CYRUS	A	P	P	P	A	P	P	P	P	P	P	P	P
41	18T91A0535	PALINGI AJAY	P	P	P	P	P	P	P	P	A	P	P	P	P
42	18T91A0536	PALIVELA JASHNAVI	P	P	P	P	P	P	P	P	P	P	P	P	P
43	18T91A0537	KAVYA DEVADA	P	P	A	P	P	P	P	P	P	P	P	P	P
44	18T91A0538	PALLA GANGA BHAVANI	P	P	P	P	P	P	P	P	A	P	P	P	P
45	18T91A0539	PALLA SIVA RAMA KRISHNA	P	P	P	P	P	P	P	P	P	P	P	P	P
46	18T91A0540	PAVANI MATAPARTHI	P	P	A	P	P	P	P	P	P	P	P	P	P
47	18T91A0542	RAGHAVA SINGH JAHNAVI	P	P	P	P	P	P	P	P	P	P	P	P	P
48	18T91A0543	RAVIPATI SRI MANI SAICHANDRA MAHESH	P	P	P	P	P	P	P	P	A	P	P	P	P
49	18T91A0544	SETTI NEELESH KUMAR	P	A	P	P	P	P	P	P	P	P	P	P	P
50	18T91A0545	SINGAVARAPU ISHWARYA	P	P	P	P	P	P	P	P	P	P	P	P	P
51	18T91A0547	SURAMPUDI VANI	P	P	P	P	P	P	P	A	P	P	P	P	P

Principal  
 GEP ENGINEERING COLLEGE,  
 No. 16 Chaitanya Knowledge City,  
 RAJAHMUNDRY-533296.



# GIET ENGINEERING COLLEGE

NH- 16, Chaitanya Knowledge City, GIET Campus, Rajamahendravaram,  
Andhra Pradesh-533296 Website: <http://www.gietec.ac.in> Email: [principalgce@giet.ac.in](mailto:principalgce@giet.ac.in)

Date:20.02.2021

## PROGRAM REPORT

- Name of the Program : "Add-on Certificate Program On .Net Framework Programming".
- Date/Duration : 05.02.2021 to 18.02.2021 (Two Week).
- Resource Perso : Mr. Y. Durga Prasad  
Assistant Professor, CSE.  
Phone: 9745326713  
Mail: [dprasadcse@giet.ac.in](mailto:dprasadcse@giet.ac.in)
- Name of the Coordinator : Mrs.Archana, Assistant Professor, CSE.
- No of the Participants : 58
- Program Objective :
- Develop console and Windows applications.
  - Learn about data access mechanisms provided by ADO.NET.
  - Create and consume .dll libraries.
  - Create a web application using .NET.
  - Use ASP.NET and IIS for making user views and applications more secure.
  - Develop WebService and Consume WebService.
- Program Outcome :
- Following are the Program Outcomes:
  - Understand the Microsoft .NET Framework and ASP.NET page structure
  - Design web application with variety of controls
  - Use Microsoft ADO.NET to access data in web Application
  - Configure and deploy Web Application
  - Develop secured web application

*Archana*  
Coordinator

*[Signature]*  
Principal  
GIET ENGINEERING COLLEGE,  
NH-16, Chaitanya Knowledge City,  
RAJAHMUNDRY - 533 296.

*[Signature]*  
HOD



# GIET ENGINEERING COLLEGE

Approved by AICTE, New Delhi/Affiliated to JNTUK, Kakinada/Accredited by NAAC  
NH-16, Chaitanya Knowledge City, GIET Campus, Rajamahendravaram-533296, AP, India.  
Phone: 96529 29111, Website: [www.gietec.ac.in](http://www.gietec.ac.in), Email: [principalgec@giet.ac.in](mailto:principalgec@giet.ac.in)

## CERTIFICATE

Certified that Mr./Ms. Mukku Hanisha

bearing the PIN 18 T 91 A 0531 studying III B.Tech./~~MBA~~ in the

department of CSE has attended the add-on/certificate course on

. NET Framework Programming from 05-02-2021 to

18-02-2021 during the academic year 2020-2021. He/ She is advised to

maintain the same spirit in his/her future endeavors.

  
Coordinator

  
HOD

  
Principal  
GIET ENGINEERING COLLEGE,  
NH-16, Chaitanya Knowledge City,  
RAJAMUNDRY-533296

  
Principal





# GIET ENGINEERING COLLEGE

Approved by AICTE, New Delhi/Affiliated to JNTUK, Kakinada/Accredited by NAAC  
NH-16, Chaitanya Knowledge City, GIET Campus, Rajamahendravaram-533296, AP, India.  
Phone: 96529 29111, Website: [www.gietec.ac.in](http://www.gietec.ac.in), Email: [principalgec@giet.ac.in](mailto:principalgec@giet.ac.in)

## CERTIFICATE

Certified that Mr./Ms. Kodavati Rakesh

bearing the PIN 18T91A0522 studying III B.Tech./MBA in the

department of CSE has attended the add-on/certificate course on

.NET Framework Programming from 05-02-2021 to

18-02-2021 during the academic year 2020-2021. He/She is advised to

maintain the same spirit in his/her future endeavors.

*Aschan*  
Coordinator

*[Signature]*  
HOD

*[Signature]*  
Principal  
GIET ENGINEERING COLLEGE  
NH-16, Chaitanya Knowledge City,  
RAJAHMUNDRY-533 296. *[Signature]*  
Principal



# GIET ENGINEERING COLLEGE

Approved by AICTE, New Delhi/Affiliated to JNTUK, Kakinada/Accredited by NAAC  
NH-16, Chaitanya Knowledge City, GIET Campus, Rajamahendravaram-533296, AP, India.  
Phone: 96529 29111, Website: [www.gietec.ac.in](http://www.gietec.ac.in), Email: [principalgec@giet.ac.in](mailto:principalgec@giet.ac.in)

## CERTIFICATE

Certified that Mr./Ms. Birre Gangadhar

bearing the PIN 18T91A0510 studying III B.Tech./MBA in the

department of CSE has attended the add-on/certificate course on

.NET Framework Programming from 05-02-2021 to

18-02-2021 during the academic year 2020 - 2021. He/ ~~She~~ is advised to

maintain the same spirit in his/~~her~~ future endeavors.

*Aechare*  
Coordinator

*[Signature]*  
HOD

*[Signature]*  
Principal  
GIET ENGINEERING COLLEGE,  
NH-16, Chaitanya Knowledge City,  
RAJAHMUNDRY-533 296.

*[Signature]*  
Principal



# GIET ENGINEERING COLLEGE

Approved by AICTE, New Delhi/Affiliated to JNTUK, Kakinada/Accredited by NAAC  
NH-16, Chaitanya Knowledge City, GIET Campus, Rajamahendravaram-533296, AP, India.  
Phone: 96529 29111, Website: [www.gietec.ac.in](http://www.gietec.ac.in), Email: [principalgec@giet.ac.in](mailto:principalgec@giet.ac.in)

## CERTIFICATE

Certified that Mr./Ms. Emani Naga Srinija

bearing the PIN 18MUIA0520 studying III B.Tech./~~MBA~~ in the

department of CSE has attended the add-on/certificate course on

.NET Framework Programming from 05-02-2021 to

18-02-2021 during the academic year 2020-2021. He/ She is advised to

maintain the same spirit in his/her future endeavors.

*Aechore*  
Coordinator

*(Signature)*  
HOD

*(Signature)*  
Principal  
GIET ENGINEERING COLLEGE  
NH-16, Chaitanya Knowledge City,  
RAJAHMUNDY-533 296.



# GIET ENGINEERING COLLEGE

Approved by AICTE, New Delhi/Affiliated to JNTUK, Kakinada/Accredited by NAAC  
NH-16, Chaitanya Knowledge City, GIET Campus, Rajamahendravaram-533296, AP, India.  
Phone: 96529 29111, Website: [www.gietec.ac.in](http://www.gietec.ac.in), Email: [principalgec@giet.ac.in](mailto:principalgec@giet.ac.in)

## CERTIFICATE

Certified that Mr./Ms. Kavya Devada

bearing the PIN 18T91A0537 studying III ~~B.Tech./MBA~~ in the  
department of CSE has attended the add-on/certificate course on

.NET Framework Programming from 05-02-2021 to  
18-02-2021 during the academic year 2020-2021. He/ She is advised to

maintain the same spirit in his/her future endeavors.

*Anchore*  
Coordinator

*[Signature]*  
HOD

*[Signature]*  
Principal  
GIET ENGINEERING COLLEGE  
NH-16, Chaitanya Knowledge City,  
RAJAHMUNDRY-533 296.

**Organising Committee**

**Chief Patron**

Shri. KVV Satyanarayana Raju  
Chairman, Chaitanya Group

**Patrons**

Shri. K. Sasi Kiran Varma  
Vice-chairman, Chaitanya Group  
Smt. K. V. V. Lakshmi  
Executive Director, Chaitanya Group

**Co-Patrons**

Dr. D. L. N. Raju  
CEO, Chaitanya Group  
P. Subba Raju  
General Manager, GIET Institutions

**Chairperson**

Dr. T. Vamsee Kiran  
Principal, GIET Engineering College

**Convener**

Dr. B. Jagdeesh  
Head of the department,  
Department of Electronics and Communication  
Engineering  
Email: [ece.gec@giet.ac.in](mailto:ece.gec@giet.ac.in)

**Co-ordinator**

Mrs. V. Lavanya,  
Assistant Professor,  
Department of Electronics and Communication  
Engineering  
Mobile No: 9000942686  
Email id: v.lavanya@gmail.com

**A Two Week Add on Program on  
“Antenna Concepts and its  
Applications”**

**REGISTRATION FORM**

1. Name of the Participant:
2. Class:
3. Roll Number:
4. Academic Year:
5. Branch:
6. Phone Number:
7. Email ID:
8. Address for Communication:
9. Signature of Participant:
10. Signature of class teacher:
11. Remarks (if any)

Date:  
Station:

**Principal**  
**GIET ENGINEERING COLLEGE,**  
**NH-16, Chaitanya Knowledge City,**  
**RAJAHMUNDRY-533 296.**

**HOD**



**A Two Week Add on Program on  
“Antenna Concepts and its  
Applications”  
09.02.2021 to 22.02.2021**



**Organized  
by  
DEPARTMENT OF  
ELECTRONICS AND COMMUNICATION  
ENGINEERING**

**GIET ENGINEERING COLLEGE**

(Formerly Known as Chaitanya Institute of Engineering & Technology)  
Approved by NICTE | Affiliated to JNTUK, Kakinada | Accredited by NAAC

NH-16, Chaitanya Knowledge City, GIET  
Campus, Rajamahendravaram, AP.

### About the Institute

The college is located at Chaitanya Nagar on NH-16 on the outskirts of Rajamahendravaram, in GIET campus. GIET Engineering College is an epitome of excellence in every aspect. Institute is Approved by AICTE and affiliated to JNTUK, Kakinada, Andhra Pradesh.

The Institute got accredited by NAAC. The institute offers undergraduate programs in diverse engineering streams. It features state-of-the-art facilities and a highly qualified and knowledgeable pool of staff members apart from the prescribed course curriculum, the institute offers an entire educational experience with greater exposure of students advanced skill learning via existing centres of excellence. It has been a pioneer in adopting several pedagogic innovations for the benefit of students. The achievements of the students of this institution in academics as well as placements stand testimony to the fact.



### About the Department

The department of Electronics & Communication Engineering was established in the year 2005 with an initial intake of 60 students. The undergraduate program of the department of Electronics and Communication imparts solid technical background and research capabilities among the students which help them to excel in their respective fields.

It has an array of courses for students to choose from and study such as electronics, electronic hardware and software, communications, radio and television, solid state device, microelectronics, VLSI, and other circuits & systems used in varying applications ranging from simple circuits to sophisticated digital satellite systems, GSM & CDMA technology, speech processing & computer development.

The quality teaching and guidance by highly experienced faculty members provide the best quality educational experience to the students. The regular interaction between students and faculty helps a student to apply theoretical knowledge to real-life situations. Moreover, the faculty members organize special sessions for topics such as electronics, communication, control system, networking, etc. that assures their placement in renowned multinational companies.

### About the Program

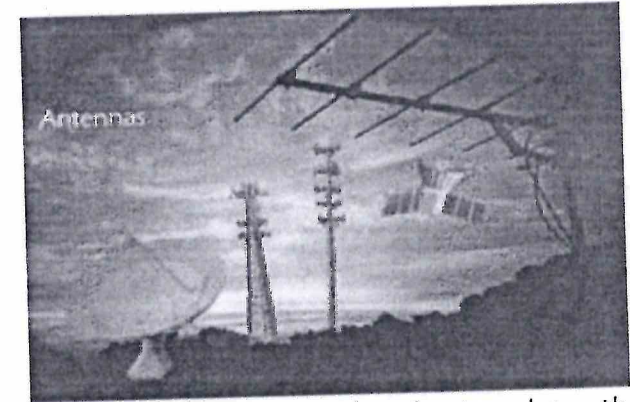

Antennas are considered to be the fundamental part of a wireless communication system. An Antenna is a device that changes the RF signal into an equivalent electromagnetic wave. So that it can be transmitted into free space. As we know that antennas are required at the time of both transmission and reception. Thus radio wave communication needs transmitting as well as receiving antennas.

These are used in radio and television signal transmission along with GPS and navigation system. Antennas are used in satellite communication, remote sensing, and biomedical applications as well.

#### Resource Person

**Mrs. G. Srujana**  
Assistant Professor,  
GIET Engineering College,  
Rajahmundry.  
Mobile No: 9440784132  
Email id: suji434@gmail.com



## GIET ENGINEERING COLLEGE

NH - 16, Chaitanya Knowledge City, GIET Campus, Rajamahendravaram,  
Andhra Pradesh - 533296 Website: <http://www.gietec.ac.in> Email: [principalgiet@giet.ac.in](mailto:principalgiet@giet.ac.in)

List of students enrolled for A Two Week Certificate Program on Antenna Concepts and its Applications

S.NO	PIN NO	NAME OF THE STUDENT	PROGRAM NAME	YEAR-SEMETER	SIGNATURE OF STUDENT
1	19T91A0401	DARBHA DEVI PRATHYUSHA	B.Tech-ECE	II-II	D. Prathyusha
2	19T91A0402	DEVINENI HARI KRISHNA	B.Tech-ECE	II-II	D. Hari Krishna
3	19T91A0403	SUNKARA SIDDARTHA	B.Tech-ECE	II-II	S. Siddartha
4	19T91A0404	VAKALAPUDI VENKATA RAMA	B.Tech-ECE	II-II	V. Venkata Rama
5	19T91A0405	GARAGA AJAYKUMAR	B.Tech-ECE	II-II	G. Ajay Kumar
6	19T91A0406	RAMINENI VENKATA SRIKANTH	B.Tech-ECE	II-II	R. Srikanth
7	19T91A0407	MAHADEVU CHANDRA PAUL	B.Tech-ECE	II-II	M. Chandrapaul
8	19T91A0408	KONDA PHANI	B.Tech-ECE	II-II	K. Phani
9	19T91A0409	GAJJARAPU MRUDHULA	B.Tech-ECE	II-II	G. Mrudhula
10	19T91A0410	VEMULURI DIVYA	B.Tech-ECE	II-II	V. Divya
11	19T91A0412	TADIKUPPALA SRINIVAS	B.Tech-ECE	II-II	T. Srinivas
12	19T91A0413	BANDARU DIVYA	B.Tech-ECE	II-II	B. Divya
13	19T91A0414	MAMMU PAVAN KALYAN	B.Tech-ECE	II-II	M. Pavan Kalyan
14	19T91A0415	NALLAMILLI ASWINI	B.Tech-ECE	II-II	N. Aswini
15	19T91A0416	GOKA JITHENDRA	B.Tech-ECE	II-II	G. Jithendra
16	19T91A0417	EATI HARI PRIYA	B.Tech-ECE	II-II	E. Hari Priya
17	19T91A0418	JANNI RAMA DEVI	B.Tech-ECE	II-II	J. Rama Devi
18	19T91A0419	NAKKA DEEPAK	B.Tech-ECE	II-II	N. Deepak
19	19T91A0420	GUDDETI HARSHA VARDHAN REDDY	B.Tech-ECE	II-II	G. Vardhan Reddy
20	19T91A0421	MANIKONDA NAGARJUNA REDDY	B.Tech-ECE	II-II	M. Nagarjuna Reddy
21	19T91A0422	BATHULA PRIYANKA	B.Tech-ECE	II-II	B. Priyanka
22	19T91A0423	PANCHAKATLA AMAR KUMAR	B.Tech-ECE	II-II	P. Amar Kumar
23	19T91A0424	RELANGI J L S N SAI DHARANI	B.Tech-ECE	II-II	R.J.L.S.N.S. Dharani
24	19T91A0425	BATHULA SRAVANI	B.Tech-ECE	II-II	B. Sravani
25	19T91A0426	NALAMOTHU SRIMANNARAYANA	B.Tech-ECE	II-II	N. Srinannarayana
26	19T91A0427	MUKKURTHI DURGA PRASAD	B.Tech-ECE	II-II	M. Durga Prasad
27	19T91A0428	GOKARAKONDA SIRI TEJA	B.Tech-ECE	II-II	G. Siri Teja
28	19T91A0429	DODDA SURESH	B.Tech-ECE	II-II	D. Suresh
29	19T91A0430	RAMIREDDY JHANSI RANI	B.Tech-ECE	II-II	R. Jhansi Rani
30	19T91A0431	BAVIRISETTI V V SRI SAI LAKSHMANA AJAY	B.Tech-ECE	II-II	B.V.V.S.S.L. Ajay
31	19T91A0432	RAVIPATI VINAY	B.Tech-ECE	II-II	R. Vinay
32	19T91A0433	NUNNA NAGADURGA	B.Tech-ECE	II-II	N. Naga Durga
33	19T91A0434	YEDIDA SAILENDRANATH	B.Tech-ECE	II-II	Y. Sailendranath
34	19T91A0435	GURRAPU DIVYA	B.Tech-ECE	II-II	G. Divya
35	19T91A0436	DODDA MANIKANTA	B.Tech-ECE	II-II	D. Manikanta
36	19T91A0437	GANAPATHIRAJU RAKESH VARMA	B.Tech-ECE	II-II	G. Rakesh Varma
37	19T91A0438	DULAM RAMESH	B.Tech-ECE	II-II	D. Ramesh
38	19T91A0439	MUPPANASETHI TEJA	B.Tech-ECE	II-II	M. TEJA

Principal  
GIET ENGINEERING COLLEGE,  
NH-16, Chaitanya Knowledge City,  
RAJAHMUNDRY-533 296.

39	19T91A0440	KARRI MAHESH BABU	B.Tech-ECE	II-II	K. mahesh Babu
40	19T91A0441	SIGIREDDY JYOTHI	B.Tech-ECE	II-II	Jyothi
41	19T91A0442	BONAM KRISHNA SATYA SRI	B.Tech-ECE	II-II	B.K. Satya Sai
42	19T91A0443	PASALA KEERTHISAI	B.Tech-ECE	II-II	P. Keerthi Sai
43	19T91A0444	KETHANAPALLI DHARMATEJA	B.Tech-ECE	II-II	K. Dharmateja
44	19T91A0445	PATHURI RAVI TEJA	B.Tech-ECE	II-II	P. Raviteja
45	19T91A0446	CHITTEEDI YASHODA KUMARI	B.Tech-ECE	II-II	Ch. Yashoda
46	19T91A0447	YERUBANDI VAISHNAVI DEVI	B.Tech-ECE	II-II	V. Vaishnavi
47	19T91A0448	NADAPANA PRASANNA LAKSHMI	B.Tech-ECE	II-II	Prasanna
48	19T91A0449	TATAVARTHI SAI SRUTHI	B.Tech-ECE	II-II	T. Sai Sruthi
49	19T91A0450	BATHINA VEERENDRA	B.Tech-ECE	II-II	B. veerendra
50	19T91A0451	CHERISHMA NAGA SAI KADIMCHERLA	B.Tech-ECE	II-II	K. Cherishma
51	19T91A0453	CHINTALA YAMUNA	B.Tech-ECE	II-II	Ch. Yamuna
52	19T91A0454	NAMBURI SRIRAM	B.Tech-ECE	II-II	N. Sriram
53	19T91A0455	SANGISETTI JAHNAVI	B.Tech-ECE	II-II	S. Jahnavi
54	19T91A0456	INELLI CHITTI DEVANI	B.Tech-ECE	II-II	I. Chitti Devani
55	19T91A0457	ANASULA SATISH KUMAR	B.Tech-ECE	II-II	A. Satish Kumar
56	19T91A0458	PASAM SUNDAR	B.Tech-ECE	II-II	P. Sundar
57	19T91A0459	YENUMULA CHINNA ANKIREDDY	B.Tech-ECE	II-II	Y.C.A. Reddy
58	19T91A0460	TANAKALA JAYA HANUMAN VENKATA AJAY	B.Tech-ECE	II-II	T. J. H. V. Ajay
59	19T91A0461	YELURIPATI SAI PHANINDRAKUMAR	B.Tech-ECE	II-II	Y. Sai Phanindra
60	19T91A0462	RAJA SUDHEER BALA CHANDRA	B.Tech-ECE	II-II	R. Sudheer
61	19T91A0463	ANGANI SATISH	B.Tech-ECE	II-II	A. Satish
62	19T91A0464	VELAGALA SRINIVASA REDDY	B.Tech-ECE	II-II	V. Sriprasad
63	19T91A0466	RAPAKA BHANU PRAKASH	B.Tech-ECE	II-II	R. Bhanu Prakash
64	19T91A0467	THOTA BHASKAR	B.Tech-ECE	II-II	T. Bhaskar
65	20T95A0401	PUDI PAVAN GANESH	B.Tech-ECE	II-II	P. M. S. Prasad
66	20T95A0402	YEDIDA MANJU SIVA SATYA PRASAD	B.Tech-ECE	II-II	Y. Manju Prasad
67	20T95A0403	GUBBALA VARA PRASAD	B.Tech-ECE	II-II	G. Vara Prasad
68	20T95A0404	UDDANDA DURGA PRASAD	B.Tech-ECE	II-II	U. Durga Prasad
69	20T95A0405	BOLISETTI ARJUN	B.Tech-ECE	II-II	B. Arjun
70	20T95A0406	PANDIRI DINESH REDDY	B.Tech-ECE	II-II	P. Dinesh
71	20T95A0407	NANDURI BALA YESU	B.Tech-ECE	II-II	N. Bala Yesu
72	20T95A0408	MANEPALLI SAI SRIRAM SWAROOP	B.Tech-ECE	II-II	M. Sai Swaroop
73	20T95A0409	LANKA RAKESH	B.Tech-ECE	II-II	L. Rakesh
74	20T95A0410	ARAVA HARI NAGA BHUSHAN RAO	B.Tech-ECE	II-II	A. Hari Naga Bhushan
75	20T95A0411	MADDIPATI BALA GOPI KISHORE	B.Tech-ECE	II-II	M. B. G. Kishore
76	20T95A0412	MADDIPATI BHANU TEJA	B.Tech-ECE	II-II	M. Bhanu Teja
77	20T95A0413	LALAM JHANSI	B.Tech-ECE	II-II	L. Jhansi
78	20T95A0414	KODIBOINA VINAY	B.Tech-ECE	II-II	K. Vinay
79	20T95A0415	KANDEPI SAICHARAN	B.Tech-ECE	II-II	K. Sai Charan
80	20T95A0416	KOLLI SHANMUKHA SRINIVAS	B.Tech-ECE	II-II	K. S. Srinivas
81	20T95A0417	CHITTEMSETTY BHULAKSHMI	B.Tech-ECE	II-II	Ch. Bhulakshmi
82	20T95A0418	PALLEM SRAVYA	B.Tech-ECE	II-II	P. Sravya
83	20T95A0419	KOPANATI ESWAR	B.Tech-ECE	II-II	K. Eswar
84	20T95A0420	KOTHAPU LOKESWARA REDDY	B.Tech-ECE	II-II	K. Lokeshwar Reddy



85	20T95A0421	TAVVA NAGA HARI SIVA KRISHNA	B.Tech-ECE	II-II	G. M. H. S. Krishna
86	20T95A0422	ANAMANENI KISHORE	B.Tech-ECE	II-II	A. Kishore
87	20T95A0423	BHOGIREDDI SAI SHANKAR	B.Tech-ECE	II-II	B. Sai Shankar
88	20T95A0424	BELLAPUKONDA VEERA NARAYANA	B.Tech-ECE	II-II	B. V. Narayana
89	20T95A0425	KONDAVEETI KARTHIK	B.Tech-ECE	II-II	K. Karthik
90	20T95A0426	VELIGATLA PAVAN KALYAN	B.Tech-ECE	II-II	V. Pavan Kalyan

  
Program Coordinator

Principal  
GIET ENGINEERING COLLEGE,  
NH-16, Chaitanya Knowledge City,  
RAJAHMUNDRY - 533 296.

  
HOD



## GIET ENGINEERING COLLEGE

NH - 16, Chaitanya Knowledge City, GIET Campus, Rajamahendravaram,  
Andhra Pradesh - 533296 Website: <http://www.gietec.ac.in> Email: [principalgce@giet.ac.in](mailto:principalgce@giet.ac.in)

### DEPARTMENT OF ELECTRONICS AND COMMUNICATIONS ENGINEERING

#### Day wise Attendance

S.NO	PIN NO	NAME OF THE STUDENT	09.02.2021	10.02.2021	11.02.2021	12.02.2021	13.02.2021	15.02.2021	16.02.2021	17.02.2021	18.02.2021	19.02.2021	20.02.2021	22.02.2021
1	19T91A0401	DARBHA DEVI PRATHYUSHA	P	P	P	A	P	A	P	P	P	P	A	P
2	19T91A0402	DEVINENI HARI KRISHNA	P	P	P	P	P	P	P	P	P	P	P	P
3	19T91A0403	SUNKARA SIDDARTHA	P	P	P	P	P	P	P	P	P	P	P	P
4	19T91A0404	VAKALAPUDI VENKATA RAMA	P	A	P	P	P	P	P	A	A	P	P	P
5	19T91A0405	GARAGA AJAYKUMAR	P	P	P	P	A	P	P	P	A	P	P	P
6	19T91A0406	RAMINENI VENKATA SRIKANTH	P	P	P	A	P	P	P	P	P	P	P	P
7	19T91A0407	MAHADEVU CHANDRA PAUL	P	P	P	P	P	A	A	A	P	P	P	A
8	19T91A0408	KONDA PHANI	P	P	P	P	A	P	P	P	P	A	P	P
9	19T91A0409	GAJJARAPU MRUDHULA	A	P	P	P	P	P	P	P	P	A	P	P
10	19T91A0410	VEMULURI DIVYA	P	P	A	P	P	P	P	P	P	P	P	P
11	19T91A0412	TADIKUPPALA SRINIVAS	P	A	P	A	P	P	P	P	P	P	P	A
12	19T91A0413	BANDARU DIVYA	P	P	P	A	P	P	P	A	P	P	P	P
13	19T91A0414	MAMMU PAVAN KALYAN	P	P	P	P	P	P	P	P	P	P	P	P
14	19T91A0415	NALLAMILI ASWINI	P	P	P	P	P	P	P	P	P	P	P	P
15	19T91A0416	GOKA JITHENDRA	P	P	P	P	P	P	P	P	P	P	P	P
16	19T91A0417	EATI HARI PRIYA	P	P	P	A	P	P	P	P	P	P	P	P
17	19T91A0418	JANNI RAMA DEVI	P	A	P	P	P	P	P	P	P	P	P	P
18	19T91A0419	NAKKA DEEPAK	P	P	A	P	P	A	P	A	P	P	P	P
19	19T91A0420	GUDETI HARSHA VARDHAN REDDY	A	P	P	P	P	P	P	P	P	P	P	P
20	19T91A0421	MANIKONDA NAGARJUNA REDDY	P	P	P	P	P	P	P	A	P	P	P	P
21	19T91A0422	BATHULA PRIYANKA	P	P	P	P	P	A	P	P	A	P	P	P
22	19T91A0423	PANCHAKATLA AMAR KUMAR	P	P	P	A	P	P	P	P	P	A	P	P
23	19T91A0424	RELANGI J L S N SAI DHARANI	P	P	P	P	P	P	P	P	P	P	P	P
24	19T91A0425	BATHULA SRAVANI	A	P	P	P	P	P	P	P	P	P	P	P
25	19T91A0426	NALAMOTHU SRIMANNARAYANA	P	P	P	P	P	P	P	P	P	P	P	P
26	19T91A0427	MUKKURTHI DURGA PRASAD	P	P	P	P	P	P	P	P	P	P	P	P
27	19T91A0428	GOKARAKONDA SIRI TEJA	P	P	P	P	P	P	P	P	P	P	P	A
28	19T91A0429	DODDA SURESH	P	P	P	P	P	P	P	P	P	P	P	P
29	19T91A0430	RAMIREDDY JHANSI RANI	P	P	P	P	P	P	P	P	P	P	P	P

Principal  
GIET ENGINEERING COLLEGE  
NH-16, Chaitanya Knowledge City,  
RAJAMAHENDRAVARAM

30	19T91A0431	BAVIRSETTI V V SRI SAI LAKSHMANA AJAY	P	P	P	P	P	A	A	A	P	P	P	P
31	19T91A0432	RAVIPATI VINAY	P	P	A	P	P	P	P	P	P	P	P	P
32	19T91A0433	NUNNA NAGADURGA	P	A	P	P	P	P	A	P	P	P	P	P
33	19T91A0434	YEDIDA SAILENDRANATH	A	P	P	P	P	P	P	P	P	P	P	P
34	19T91A0435	GURRAPU DIVYA	P	P	P	A	P	P	P	P	A	P	P	P
35	19T91A0436	DODDA MANIKANTA	P	P	P	P	A	P	P	P	P	A	P	P
36	19T91A0437	GANAPATHIRAJU RAKESH VARMA	P	P	A	P	P	A	P	P	P	P	P	P
37	19T91A0438	DULAM RAMESH	P	P	P	P	P	P	P	P	P	P	P	P
38	19T91A0439	MUPPANASETTI TEJA	P	A	P	P	P	P	P	A	P	A	P	P
39	19T91A0440	KARRI MAHESH BABU	P	P	P	P	P	P	P	P	P	P	P	P
40	19T91A0441	SIGIREDDY JYOTHI	P	P	P	P	P	A	P	P	P	P	P	P
41	19T91A0442	BONAM KRISHNA SATYA SRI	P	A	P	P	P	P	A	P	P	P	P	P
42	19T91A0443	PASALA KEERTHISAI	P	P	P	P	A	P	P	P	A	P	P	P
43	19T91A0444	KETHANAPALLI DHARMATEJA	P	P	P	P	P	A	P	P	A	P	P	P
44	19T91A0445	PATHURI RAVI TEJA	P	P	P	A	P	P	P	P	P	P	P	P
45	19T91A0446	CHITTEEDI YASHODA KUMARI	P	P	A	P	P	P	P	P	P	P	P	P
46	19T91A0447	YERUBANDI VAISHNAVI DEVI	A	P	P	P	P	P	P	P	P	P	P	P
47	19T91A0448	NADAPANA PRASANNA LAKSHMI	P	P	P	P	P	P	P	P	P	P	P	P
48	19T91A0449	TATAVARTHI SAI SRUTHI	P	P	P	A	P	P	P	P	P	P	P	P
49	19T91A0450	BATHINA VEERENDRA	P	P	P	P	A	P	A	P	P	P	P	P
50	19T91A0451	CHERISHMA NAGA SAI KADIMCHERLA	P	P	P	P	P	P	P	P	P	P	P	P
51	19T91A0453	CHINTALA YAMUNA	P	P	P	P	P	A	P	P	P	P	P	P
52	19T91A0454	NAMBURI SRIRAM	P	P	P	P	P	P	P	P	P	P	P	P
53	19T91A0455	SANGISETTI JAHNAVI	P	P	P	P	A	P	P	P	P	P	P	P
54	19T91A0456	INELLI CHITTI DEVANI	P	P	P	P	P	P	P	A	P	P	P	P
55	19T91A0457	ANASULA SATISH KUMAR	P	P	P	P	P	P	P	P	A	P	P	P
56	19T91A0458	PASAM SUNDAR	P	P	P	P	P	P	P	P	P	P	P	P
57	19T91A0459	YENUMULA CHINNA ANKIREDDY	P	P	P	P	P	P	P	P	P	P	P	P
58	19T91A0460	TANAKALA JAYA HANUMAN VENKATA AJAY	A	A	P	P	P	P	A	P	P	P	P	P
59	19T91A0461	YELURIPATI SAI PHANINDRAKUMAR	P	P	P	P	P	P	P	P	P	P	P	P
60	19T91A0462	RAJA SUDHEER BALA CHANDRA	P	P	A	P	P	P	P	P	P	P	P	P
61	19T91A0463	ANGANI SATISH	P	P	P	P	P	P	P	P	P	P	P	P
62	19T91A0464	VELAGALA SRINIVASA REDDY	P	P	P	P	P	P	P	P	P	P	P	P
63	19T91A0466	RAPAKA BHANU PRAKASH	P	A	P	P	P	P	P	P	P	P	P	P
64	19T91A0467	THOTA BHASKAR	P	P	P	P	P	P	P	P	P	P	P	P
65	20T95A0401	PUDI PAVAN GANESH	P	P	A	P	P	A	P	P	A	P	P	P

Principal  
 GIET ENGINEERING COLLEGE,  
 NH-16, Chaitanya Knowledge City,  
 RAJAHMUNDRY-533 283.

66	20T95A0402	YEDIDA MANJU SIVA SATYA PRASAD	P	P	P	P	P	A	P	P	A	P	P	P
67	20T95A0403	GUBBALA VARA PRASAD	P	P	P	P	P	P	A	P	P	P	P	P
68	20T95A0404	UDDANDA DURGA PRASAD	P	P	A	P	A	P	P	A	P	P	P	P
69	20T95A0405	BOLISETTI ARJUN	P	P	P	A	P	P	P	P	P	A	P	P
70	20T95A0406	PANDIRI DINESH REDDY	P	P	P	P	P	A	P	P	P	P	P	P
71	20T95A0407	NANDURI BALA YESU	P	P	P	P	P	P	P	P	P	P	P	P
72	20T95A0408	MANEPALLI SAI SRIRAM SWAROOP	P	P	P	P	P	P	P	P	P	P	P	P
73	20T95A0409	LANKA RAKESH	P	P	P	A	P	P	P	P	A	P	P	P
74	20T95A0410	ARAVA HARI NAGA BHUSHAN RAO	A	P	P	P	P	P	P	P	P	P	P	P
75	20T95A0411	MADDIPATI BALA GOPI KISHORE	P	A	P	P	A	P	P	P	P	P	P	P
76	20T95A0412	MADDIPATI BHANU TEJA	P	P	A	P	P	P	A	P	A	P	P	P
77	20T95A0413	LALAM JHANSI	P	P	P	P	P	P	P	P	P	P	P	P
78	20T95A0414	KODIBOINA VINAY	P	P	P	P	P	P	P	P	A	P	P	P
79	20T95A0415	KANDEPI SAICHARAN	P	P	P	P	P	P	A	P	A	P	P	A
80	20T95A0416	KOLLI SHANMUKHA SRINIVAS	P	P	P	P	P	P	P	H	P	P	P	P
81	20T95A0417	CHITTEMSETTY BHULAKSHMI	P	P	P	P	P	P	P	P	P	P	A	P
82	20T95A0418	PALLEM SRAVYA	P	P	P	A	P	P	P	P	P	P	P	P
83	20T95A0419	KOPANATI ESWAR	P	P	P	P	P	A	P	P	P	P	P	P
84	20T95A0420	KOTHAPU LOKESWARA REDDY	A	P	P	P	P	P	P	P	A	P	P	A
85	20T95A0421	TAVVA NAGA HARI SIVA KRISHNA	P	A	P	P	P	P	P	P	P	P	P	P
86	20T95A0422	ANAMANENI KISHORE	P	P	P	P	P	P	P	P	P	A	P	P
87	20T95A0423	BHOGIREDDI SAI SHANKAR	P	P	P	P	P	P	P	A	P	P	P	P
88	20T95A0424	BELLAPUKONDA VEERA NARAYANA	P	P	A	P	P	P	P	P	P	P	P	P
89	20T95A0425	KONDAVEETI KARTHIK	P	P	P	P	P	P	P	P	P	P	P	P
90	20T95A0426	VELIGATLA PAVAN KALYAN	P	P	P	P	P	A	P	P	P	P	P	P

  
Program Coordinator

Principal  
GIET ENGINEERING COLLEGE,  
NH-16, Chaitanya Knowledge City,  
RAJAHMUNDRY - 533 296.

  
HOD



# GIET ENGINEERING COLLEGE

NH - 16, Chaitanya Knowledge City, GIET Campus, Rajamahendravaram,  
Andhra Pradesh - 533296 Website: <http://www.gietec.ac.in> Email: [principalgec@giet.ac.in](mailto:principalgec@giet.ac.in)

---

Date:24.02.2021

## PROGRAM REPORT

**Name of the Event: A Two Week Certificate Program on Antenna Concepts and its Applications**

**Date: 09.02.2022 to 22.02.2021**

**Resource Person: Mrs. G.Srujana**

AssistantProfessor ECE, GIET Engineering college

Email.id: [suji434@gmail.com](mailto:suji434@gmail.com)

Contact number: 9440784132

**Name of the Coordinator:Mrs.V.Lavanya**

**Number of students attended:90**

**Venue:Seminar Hall, C V Raman Block, GIET Engineering college**

### **Objectives of the Program:**

- Student will learn fundamental antenna parameters
- To Learn the concepts of UHF and VHF antennas
- To introduce antenna filters and phased array effects

Principal  
GIET ENGINEERING COLLEGE,  
NH-16, Chaitanya Knowledge City,  
RAJAHMUNDRY-533 296.

**Topics to be covered:**

- How antenna works
- Test basic antennas
- How to use computer simulation to analyse various types of antennas
- Mathematical and physical principles of antenna courses
- Environmental impacts on antenna performance
- Choosing antennas for specific applications

**Outcomes of the Program:**

- At the end of this course, the student will be able to
1. Understand the Concepts of Antenna and its Applications
  2. Measure the parameters of antenna
  3. Analyse and identify different types antennas.

  
**Coordinator**

  
Principal  
**GIET ENGINEERING COLLEGE,**  
NH-16, Chaitanya Knowledge City,  
RAJAHMUNDRY - 533 296.

  
**HOD-ECE**



# GIET ENGINEERING COLLEGE

Approved by AICTE, New Delhi/Affiliated to JNTUK, Kakinada/Accredited by NAAC  
NH-16, Chaitanya Knowledge City, GIET Campus, Rajamahendravaram-533296, AP, India.  
Phone: 96529 29111, Website: [www.gietec.ac.in](http://www.gietec.ac.in), Email: [principalgec@giet.ac.in](mailto:principalgec@giet.ac.in)

## CERTIFICATE

Certified that Mr./Ms. PATHURI RAVI TEJA

bearing the PIN 19791A0445 studying II-II B.Tech./ MBA in the

department of FCE has attended the add-on/certificate course on

ANTENNA CONCEPTS AND IT'S APPLICATIONS from 09-02-2021 to

22-02-2021 during the academic year 2020-21. He/ She is advised to

maintain the same spirit in his/her future endeavors.

  
Coordinator

  
HOD

  
Principal  
GIET ENGINEERING COLLEGE.  
NH-16, Chaitanya Knowledge City,  
RAJAHMUNDRY-533 296.

  
Principal



# GIET ENGINEERING COLLEGE

Approved by AICTE, New Delhi/Affiliated to JNTUK, Kakinada/Accredited by NAAC  
NH-16, Chaitanya Knowledge City, GIET Campus, Rajamahendravaram-533296, AP, India.  
Phone: 96529 29111, Website: [www.gietec.ac.in](http://www.gietec.ac.in), Email: [principalgec@giet.ac.in](mailto:principalgec@giet.ac.in)

## CERTIFICATE

Certified that Mr./Ms. BHOGIREDDI. SAI SHANKAR

bearing the PIN 20T95A0423 studying II-II B.Tech./ MBA in the

department of FCE has attended the add-on/certificate course on

ANTENNA CONCEPT'S AND IT'S APPLICATIONS from 09-02-2021 to

22-02-2021 during the academic year 2020-21. He/ She is advised to

maintain the same spirit in his/her future endeavors.

  
Coordinator

  
HOD

  
Principal  
GIET ENGINEERING COLLEGE,  
NH-16, Chaitanya Knowledge City,  
RAJAHMUNDRY-533 296.

  
Principal





# GIET ENGINEERING COLLEGE

Approved by AICTE, New Delhi/Affiliated to JNTUK, Kakinada/Accredited by NAAC  
NH-16, Chaitanya Knowledge City, GIET Campus, Rajamahendravaram-533296, AP, India.  
Phone: 96529 29111, Website: [www.gietec.ac.in](http://www.gietec.ac.in), Email: [principalgec@giet.ac.in](mailto:principalgec@giet.ac.in)

## CERTIFICATE

Certified that Mr./Ms. PALLEM SRAYYA

bearing the PIN 20T95A0418 studying II-II B.Tech./ MBA in the

department of ECE has attended the add-on/certificate course on

ANTENNA CONCEPTS AND IT'S APPLICATIONS from 09-02-2021 to

22-02-2021 during the academic year 2020-21. He/ She is advised to

maintain the same spirit in his/her future endeavors.

  
Coordinator

  
HOD

  
Principal  
GIET ENGINEERING COLLEGE,  
NH-16, Chaitanya Knowledge City,  
RAJAHMUNDRY-533 296.

  
Principal



# GIET ENGINEERING COLLEGE

Approved by AICTE, New Delhi/Affiliated to JNTUK, Kakinada/Accredited by NAAC  
NH-16, Chaitanya Knowledge City, GIET Campus, Rajamahendravaram-533296, AP, India.  
Phone: 96529 29111, Website: [www.gietec.ac.in](http://www.gietec.ac.in), Email: [principalgec@giet.ac.in](mailto:principalgec@giet.ac.in)

## CERTIFICATE

Certified that Mr./Ms. ANGANI SATISH

bearing the PIN 19T91A0463 studying II-II B.Tech./ MBA in the  
department of ECE has attended the add-on/certificate course on

ANTENNA CONCEPTS AND IT'S APPLICATIONS from 09-02-2021 to  
22-02-2021 during the academic year 2020-21. He/ She is advised to

maintain the same spirit in his/her future endeavors.

  
Coordinator

  
HOD

  
Principal  
GIET ENGINEERING COLLEGE,  
NH-16, Chaitanya Knowledge City,  
RAJAHMUNDRY-533 296.

  
Principal



# GIET ENGINEERING COLLEGE

Approved by AICTE, New Delhi/Affiliated to JNTUK, Kakinada/Accredited by NAAC  
NH-16, Chaitanya Knowledge City, GIET Campus, Rajamahendravaram-533296, AP, India.  
Phone: 96529 29111, Website: [www.gietec.ac.in](http://www.gietec.ac.in), Email: [principalgec@giet.ac.in](mailto:principalgec@giet.ac.in)

## CERTIFICATE

Certified that Mr./Ms. VEMULURI DIVYA

bearing the PIN 19T91A0410 studying II-II B.Tech./ MBA in the

department of ECE has attended the add-on/certificate course on

ANTENNA CONCEPTS AND IT'S APPLICATIONS from 09-02-2021 to

22-02-2021 during the academic year 2020-21. He/ She is advised to

maintain the same spirit in his/her future endeavors.

  
Coordinator

  
HOD

  
Principal  
GIET ENGINEERING COLLEGE,  
NH-16, Chaitanya Knowledge City,  
RAJAHMUNDRY-533 296.

  
Principal

### Organising Committee

#### Chief Patron

Shri. KVV Satyanarayana Raju  
Chairman, Chaitanya Group

#### Patrons

Shri. K. Sasi Kiran Varma  
Vice-chairman, Chaitanya Group  
Smt. K. V. V. Lakshmi  
Executive Director, Chaitanya Group

#### Co-Patrons

Dr. D. L. N. Raju  
CEO, Chaitanya Group  
P. Subba Raju  
General Manager, GIET Institutions

#### Chairperson

Dr.T.Vamsee Kiran  
Principal, GIET Engineering College

#### Convener

Mr.A.V.Sridhar,  
Associate Professor,  
Department of Mechanical Engineering  
Mobile No: 9908942849  
Email iddrsridharav@gmail.com

#### Co-ordinator

Mr.P.Vipin Raj  
Assistant Professor,  
Department of Mechanical Engineering  
Email: vipinraj777@gmail.com

## A Two Week Add on Program on "REVIT"

### REGISTRATION FORM

1. Name of the Participant:
2. Class:
3. Roll Number:
4. Academic Year:
5. Branch:
6. Phone Number:
7. Email ID:
8. Address for Communication:
9. Signature of Participant:
10. Signature of class teacher:
11. Remarks (if any)

Date:  
Station:

  
**Principal**  
**GIET ENGINEERING COLLEGE,**  
**NH-16, Chaitanya Knowledge City,**  
**RAJAHMUNDRY-533 296.**

HOD



## A Two Week Add on Program on "REVIT"

09.02.2021 to 22.02.2021



Organized  
by

DEPARTMENT OF  
MECHANICAL ENGINEERING  
**GIET ENGINEERING COLLEGE**  
(Formerly Known as Chaitanya Institute of Engineering & Technology)  
Approved by AICTE | Affiliated to JNTUK, Kakinada | Accredited by NAAC

NH-16, Chaitanya Knowledge City, GIET  
Campus, Rajamahendravaram, AP.

### About the Institute

The college is located at Chaitanya Nagar on NH-16 on the outskirts of Rajamahendravaram, in GIET campus. GIET Engineering College is an epitome of excellence in every aspect. Institute is Approved by AICTE and affiliated to JNTUK, Kakinada, Andhra Pradesh.

The Institute got accredited by NAAC. The institute offers undergraduate programs in diverse engineering streams. It features state-of-the-art facilities and a highly qualified and knowledgeable pool of staff members. Apart from the prescribed course curriculum, the institute offers an entire educational experience with greater exposure of students advanced skill learning via existing centres of excellence. It has been a pioneer in adopting several pedagogic innovations for the benefit of students. The achievements of the students of this institution in academics as well as placements stand testimony to the fact.



### About the Department

Mechanical engineering is an evergreen discipline that involved in the application of basic science and mathematical principles to design, analyze, manufacture, and maintenance of mechanical systems. Mechanical engineers work across a huge variety of industries. Mechanical engineers are in the design, manufacture and maintenance of things ranging from a small safety pin to a giant ship. It is one of the oldest branches of engineering, it is also one that continues to change and grow with the advancements in technology making it a vibrant and exciting career path even to this day. The total number of engineers employed in the U.S. in 2015 was roughly 1.6 million. Of these 17.28% were mechanical engineers, the largest discipline by size.

The department is equipped with academically sound and experienced faculty specialized in various areas of mechanical engineering. The department is provided with state of the art laboratories and software. In addition to the regular curriculum we conduct programs like add-on training programs on drafting, solid modelling, etc., Industrial visits, Seminars, Hands-on workshops on latest technologies to enhance the skills of the students to meet the demands of the industry.

### About the Program

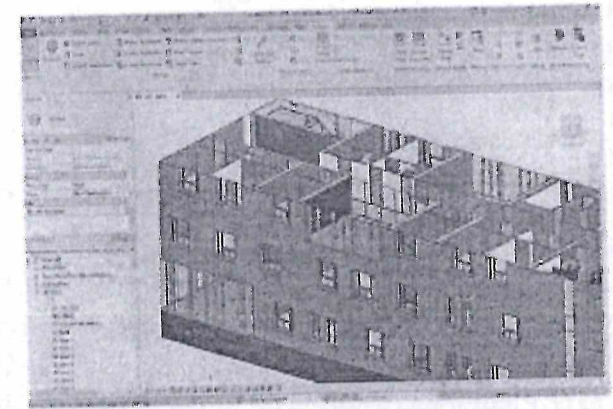

Revit is a commercial building information modeling (BIM) software by the company Autodesk. It's generally used by architects, structural engineers, mechanical, electrical, and plumbing (MEP) engineers, designers, and contractors. Autodesk Revit allows users to create, edit, and review 3D models in exceptional detail

#### Resource Person

**Mr.K.V.G.Praveen**

Assistant Professor

GIET Engineering College,

Rajahmundry.

Mobile No:8499063164

Email id: kvgpraveen107@gmail.com



## GIET ENGINEERING COLLEGE

NH - 16, Chaitanya Knowledge City, GIET Campus, Rajamahendravaram,  
Andhra Pradesh - 533296 Website: <http://www.gietec.ac.in> Email: [principalce@giet.ac.in](mailto:principalce@giet.ac.in)

### List of students enrolled for A Two Week Certificate Program on REVIT

S.NO	PIN NO	NAME OF THE STUDENT	PROGRAM NAME	YEAR-SEMETER	SIGNATURE OF STUDENT
1	17MU1A0301	KAPARAPU LOKESH	B.TECH	IV-II	K. Lokesh
2	17MU1A0302	KARINIKI SUBRAMANYAM	B.TECH	IV-II	K. Subramanyam
3	17MU1A0304	KARIMULLA	B.TECH	IV-II	Karimulla
4	18MU5A0301	VENKAT PAUL	B.TECH	IV-II	Venkat Paul
5	18MU5A0303	KALKI VENKATESH	B.TECH	IV-II	V. Poet
6	18MU5A0304	SATYAVARAPU CHANIKAY SANTHOSH KUMAR	B.TECH	IV-II	S. Chanikay Kumar
7	16T91A0311	MATHI PRASANTH	B.TECH	IV-II	M. Prasant
8	17T91A0301	CHENNAMSETTI AJAY RAJU	B.TECH	IV-II	Aj. Raju
9	17T91A0302	CHUNDURI YAGNESHWAR	B.TECH	IV-II	D. Mahesh
10	17T91A0303	DANDU MAHESH	B.TECH	IV-II	S. Yagneshwar
11	17T91A0304	SHAIK ALI MAHABOOB RAZAK	B.TECH	IV-II	D. Mahesh
12	17T91A0305	BODDU LAKSHMI SAI KRISHNA	B.TECH	IV-II	Sai Krishna
13	17T91A0306	KOPPISETTI ASHOK SURENDRA KUMAR	B.TECH	IV-II	Surendra Kumar
14	17T91A0307	SERU SHANMUKHA DURGA PRASAD	B.TECH	IV-II	Durga Prasad
15	17T91A0309	JAGATHA TEJA DURGA RAJ	B.TECH	IV-II	Durga Raj
16	17T91A0310	GUBBLA PAVAN DURGA GANESH	B.TECH	IV-II	Durga Ganesh
17	17T91A0311	KALAVALA RAVI KUMAR	B.TECH	IV-II	J. Teja Durga Raj
18	17T91A0312	KUSUMA VIKAS BABU	B.TECH	IV-II	Vikas Babu
19	17T91A0314	GANGABATTULA N V RAVINDRA	B.TECH	IV-II	N.V Ravindra
20	17T91A0315	POLISETTI TARUN	B.TECH	IV-II	Tarun
1	17T91A0317	MOLLA JAYESH LAKSHMAN	B.TECH	IV-II	Jayesh Lakshman
2	17T91A0318	VANAPALLI EMMANUEL	B.TECH	IV-II	Emmanuel
3	17T91A0319	YASAPU MAHESH SRINIVAS	B.TECH	IV-II	V. Emmanuel
4	17T91A0320	JETTI CHANDRA SEKHAH	B.TECH	IV-II	Mahesh Srinivas
5	17T91A0321	PADISETTI RAMA SAI	B.TECH	IV-II	Jetti Sekhar
6	17T91A0322	ULLINGI VAMSI	B.TECH	IV-II	Rama Sai
7	17T91A0323	KOLLA B S PAVAN KISHORE	B.TECH	IV-II	Vamsi
8	17T91A0325	KONDETI SIVA GOWTHAM	B.TECH	IV-II	P. Pavan
9	17T91A0327	ULISETTI VINAY	B.TECH	IV-II	Vinay
10	17T91A0328	MEDISETTI LOVARAJU	B.TECH	IV-II	LoVaraju
11	18T95A0301	ALLURI SURESH KUMAR	B.TECH	IV-II	Suresh Kumar

Principal  
GIET ENGINEERING COLLEGE,  
NH-16, Chaitanya Knowledge City,  
RAJAHMUNDRY-533 296.

S.NO	PIN NO	NAME OF THE STUDENT	PROGRAM NAME	YEAR-SEMETER	SIGNATURE OF STUDENT
32	18T95A0302	ANDIMENI NAGENDRA BABU	B.TECH	IV-II	A. Nagendra
33	18T95A0304	BADDI SRINU	B.TECH	IV-II	B. Srinu
34	18T95A0305	BANDARU PAVANKALYAN	B.TECH	IV-II	B. Pavankalyan
35	18T95A0306	BODAPATI LOKESH	B.TECH	IV-II	Pavankalash
36	18T95A0307	CHALLAGIRI SAI KRISHNA	B.TECH	IV-II	Sai Krishna
37	18T95A0308	CHINTADA SANNIKESH	B.TECH	IV-II	Sannikesh
38	18T95A0309	DARAPU BALA SATYA MURALI REDDY	B.TECH	IV-II	D. Satya murali
39	18T95A0310	GADIRAJU VENKATAPATHI RAJU	B.TECH	IV-II	Venkathathi Raju
40	18T95A0311	GOLLA BALAJI	B.TECH	IV-II	G. balaji
41	18T95A0312	GOLLAPUDI RAMESH	B.TECH	IV-II	Ramesh
42	18T95A0314	KANCHUPARTHI SURYA PRAKASH	B.TECH	IV-II	Surya Prakash
43	18T95A0315	KANTIMAHANATHI RAJKAMAL KRISTOFAR	B.TECH	IV-II	K. Rajkamal
44	18T95A0317	KEERTHI JEEVANBABU	B.TECH	IV-II	K. jeevan babu
45	18T95A0318	KETHA CHANDRA SEKSHAR	B.TECH	IV-II	K. Chandra Sekshar
46	18T95A0319	KOTHAPALLI RAVI KUMAR	B.TECH	IV-II	K. Ravi kumar
47	18T95A0320	KOYYA VEERABABU	B.TECH	IV-II	K. Veerababu
48	18T95A0321	MADDIREDDY VENKAT	B.TECH	IV-II	M. Venkat
49	18T95A0322	MALAKALA DURGARAM	B.TECH	IV-II	M. Durga Ram
50	18T95A0324	MALLIPALA SRI VENKATA RAJU	B.TECH	IV-II	M. Sri Venkata Raju
51	18T95A0325	NANDHYALA SUDHEER	B.TECH	IV-II	N. Sudheer
52	18T95A0326	NOLUGU PAVANI KANAKA MAHALAKSHMI	B.TECH	IV-II	N. Pavani kanaka
53	18T95A0328	PALLETI VENKATESH	B.TECH	IV-II	P. Venkatesh
54	18T95A0329	PILLA ARJUN	B.TECH	IV-II	P. ARJUN
55	18T95A0331	PRAGALLAPATI ESWAR	B.TECH	IV-II	P. arjun
56	18T95A0332	SOMU RAMA KRISHNA	B.TECH	IV-II	Eswar
57	18T95A0333	TUMMA VENKATA SAI	B.TECH	IV-II	T. Venkata Sai
58	18T95A0334	VEMAGIRI DURGA VENKATA PRASAD	B.TECH	IV-II	V. P. Venkata prasad

P. V. Raj  
COORDINATOR

Principal  
GIET ENGINEERING COLLEGE,  
NH-16, Chaitanya Knowledge City,  
RAJAHMUNDRY - 533 296.

Mishra  
HOD



20-21-4<sup>th</sup> year

### GIET ENGINEERING COLLEGE

NH-16, Chaitanya Knowledge City, GIET Campus, Rajamahendravaram,  
Andhra Pradesh-533296 Website: <http://www.gietec.ac.in> Email: [principalgco@giet.ac.in](mailto:principalgco@giet.ac.in)

#### DEPARTMENT OF MECHANICAL ENGINEERING

#### Day wise attendance

S.NO	PIN NO	NAME OF THE STUDENT	09-02-2021	10-02-2021	11-02-2021	12-02-2021	13-02-2021	15-02-2021	16-02-2021	17-02-2021	18-02-2021	19-02-2021	20-02-2021	22-02-2021
1	17MU1A0301	KAPARAPU LOKESH	P	P	P	P	P	A	P	P	P	P	P	P
2	17MU1A0302	KARINIKI SUBRAMANYAM	P	P	P	P	P	P	P	P	P	P	P	P
3	17MU1A0304	KARIMULLA	P	P	P	P	P	P	P	P	P	P	P	P
4	18MU5A0301	VENKAT PAUL	P	P	P	P	P	P	P	P	P	P	P	P
5	18MU5A0303	KALKI VENKATESH	P	P	P	P	P	P	P	P	P	P	P	P
6	18MU5A0304	SATYAVARAPU CHANIKAY SANTHOSH KUMAR	P	P	P	P	P	P	P	P	P	P	P	P
7	16T91A0311	MATHI PRASANTH	P	A	P	P	P	A	P	P	P	P	P	P
8	17T91A0301	CHENNAMSETTI AJAY RAJU	P	P	P	P	P	P	P	P	P	P	P	P
9	17T91A0302	CHUNDURI YAGNESHWAR	P	P	P	P	P	P	P	P	P	P	P	P
10	17T91A0303	DANDU MAHESH	P	P	P	P	P	P	P	P	P	P	P	P
11	17T91A0304	SHAIK ALI MAHABOOB RAZAK	P	P	P	P	P	P	P	P	P	P	P	P
12	17T91A0305	BODDU LAKSHMI SAI KRISHNA	P	P	P	P	P	P	P	P	P	P	P	P
13	17T91A0306	KOPPISETTI ASHOK SURENDRA KUMAR	P	P	P	P	P	P	P	P	P	P	P	P
14	17T91A0307	SERU SHANMUKHA DURGA PRASAD	P	P	P	P	P	P	P	P	P	P	P	P
15	17T91A0309	JAGATHA TEJA DURGA RAJ	P	P	P	P	P	P	P	P	P	P	P	P
16	17T91A0310	GUBBLA PAVAN DURGA GANESH	P	P	P	P	P	P	P	P	P	P	P	P
17	17T91A0311	KALAVALA RAVI KUMAR	P	P	P	P	P	P	P	P	P	P	P	P
18	17T91A0312	KUSUMA VIKAS BABU	P	P	P	P	P	P	P	P	P	P	P	P
19	17T91A0314	GANGABATTULA N V RAVINDRA	P	P	P	P	P	P	P	P	P	P	P	P
20	17T91A0315	POLISETTI TARUN	P	P	P	P	P	P	P	P	P	P	P	P
21	17T91A0317	MOLLA JAYESH LAKSHMAN	P	P	P	P	P	P	P	P	P	P	P	P
22	17T91A0318	VANAPALLI EMMANUEL	P	P	P	P	P	P	P	P	P	P	P	P
23	17T91A0319	YASAPU MAHESH SRINIVAS	P	P	P	P	P	P	P	P	P	P	P	P
24	17T91A0320	JETTI CHANDRA SEKHAR	P	P	P	P	P	P	P	P	P	P	P	P
25	17T91A0321	PADISETTI RAMA SAI	P	P	P	P	P	P	P	P	P	P	P	P
26	17T91A0322	ULLINGI VAMSI	P	P	P	P	P	P	P	P	P	P	P	P
27	17T91A0323	KOLLA B S PAVAN KISHORE	P	P	P	P	P	P	P	P	P	P	P	P
28	17T91A0325	KONDETI SIVA GOWTHAM	P	P	P	P	P	P	P	P	P	P	P	P
29	17T91A0327	ULISETTI VINAY	P	P	P	P	P	P	P	P	P	P	P	P
30	17T91A0328	MEDISETTI LOVARAJU	P	P	P	P	P	P	P	P	P	P	P	P
31	18T95A0301	ALLURI SURESH KUMAR	P	P	P	P	P	P	P	P	P	P	P	P

*Csw*

Principal  
GIET ENGINEERING COLLEGE  
NH-16, Chaitanya Knowledge City  
RAJAMUNDY-533 296.



SR NO	PIN NO	NAME OF THE STUDENT												
32	18T95A0302	ANDIMENI NAGENDRA BABU	P	P	P	P	A	P	P	P	P	P	P	P
33	18T95A0304	BADDI SRINU	P	P	P	P	P	P	P	P	P	P	P	P
34	18T95A0305	BANDARU PAVANKALYAN	P	P	P	P	P	P	P	P	P	P	P	P
35	18T95A0306	BODAPATI LOKESH	P	P	P	P	P	P	P	P	P	P	P	P
36	18T95A0307	CHALLAGIRI SAI KRISHNA	P	P	P	P	P	P	P	P	P	P	P	P
37	18T95A0308	CHINTADA SANNIKESH	P	P	P	P	P	P	P	P	P	P	P	P
38	18T95A0309	DARAPU BALA SATYA MURALI REDDY	P	P	P	P	P	P	P	P	P	P	P	P
39	18T95A0310	GADIRAJU VENKATAPATHI RAJU	P	P	P	P	P	P	P	P	P	P	P	P
40	18T95A0311	GOLLA BALAJI	P	P	P	P	P	P	P	P	P	P	P	P
41	18T95A0312	GOLLAPUDI RAMESH	P	P	P	P	P	P	P	P	P	P	P	P
42	18T95A0314	KANCHUPARTHI SURYA PRAKASH	P	P	P	P	P	P	P	P	P	P	P	P
43	18T95A0315	KANTIMAHANATHI RAJKAMAL KRISTOFAR	P	P	P	P	P	P	P	P	P	P	P	P
44	18T95A0317	KEERTHI JEEVANBABU	P	P	P	P	P	P	P	P	P	P	P	P
45	18T95A0318	KETHA CHANDRA SEKHA	P	P	P	P	P	P	P	P	P	P	P	P
46	18T95A0319	KOTHAPALLI RAVI KUMAR	P	P	P	P	P	P	P	P	P	P	P	P
47	18T95A0320	KOYYA VEERABABU	P	P	P	P	P	P	P	P	P	P	P	P
48	18T95A0321	MADDIREDDY VENKAT	P	P	P	P	P	P	P	P	P	P	P	P
49	18T95A0322	MALAKALA DURGARAM	P	P	P	P	P	P	P	P	P	P	P	P
50	18T95A0324	MALLIPALA SRI VENKATA RAJU	P	P	P	P	P	P	P	P	P	P	P	P
51	18T95A0325	NANDHYALA SUDHEER	P	P	P	P	P	P	P	P	P	P	P	P
52	18T95A0326	NOLUGU PAVANI KANAKA MAHALAKSHMI	P	P	P	P	P	P	P	P	P	P	P	P
53	18T95A0328	PALETI VENKATESH	P	P	P	P	P	P	P	P	P	P	P	P
54	18T95A0329	PILLA ARJUN	P	P	P	P	P	P	P	P	P	P	P	P
55	18T95A0331	PRAGALLAPATI ESWAR	P	P	P	P	P	P	P	P	P	P	P	P
56	18T95A0332	SOMU RAMA KRISHNA	P	P	P	P	P	P	P	P	P	P	P	P
57	18T95A0333	TUMMA VENKATA SAI	P	P	P	P	P	P	P	P	P	P	P	P
58	18T95A0334	VEMAGIRI DURGA VENKATA PRASAD	P	P	P	P	P	P	P	P	P	P	P	P

*P. V. S.*  
COORDINATOR

*S. S.*  
Principal  
GIET ENGINEERING COLLEGE,  
NH-16, Chaitanya Knowledge City,  
RAJAHMUNDRY - 533 296.

*S. S.*  
HOD



## GIET ENGINEERING COLLEGE

NH - 16, Chaitanya Knowledge City, GIET Campus, Rajamahendravaram,  
Andhra Pradesh - 533296 Website: <http://www.gietec.ac.in> Email: [principalgee@giet.ac.in](mailto:principalgee@giet.ac.in)

Date: 04-06-2021

### PROGRAM REPORT

Name of the Program : "A Two-Week Certificate Program on REVIT"

Date/Duration : 09.02.2021 to 22.02.2021 (Two Week).

Resource Person : Mr.K.V.G.PRAVEEN  
Assistant Professor,  
MECH, GIET ENGINEERING COLLEGE,  
Rajahmundry, A.P

Phone:8499063164

Mail:kvgpraveen107@gmail.com

Name of the Coordinator : Mr.P.Vipin Raj, Assistant Professor, MECH.

No of the Participants : 58

Program Objective :

- Parametric modelling
- Automation
- Collaboration
- Coordination
- Energy Analysis

Topics Covered

:The following topics are covered

- Storing data in the REVIT model
- Transactions
- Events
- External events
- Commands

  
Principal  
GIET ENGINEERING COLLEGE,  
NH-16, Chaitanya Knowledge City,  
RAJAHMUNDY-533 296.



## GIET ENGINEERING COLLEGE

NH-16, Chaitanya Knowledge City, GIET Campus, Rajamahendravaram,  
Andhra Pradesh-533296 Website: <http://www.gietec.ac.in> Email: [principalgec@giet.ac.in](mailto:principalgec@giet.ac.in)

---

### Program Outcome :

- Open the explore outcomes dialog
- In the left pane, select the study to explore
- To see details for an outcome, click its thumbnails

  
Coordinator

  
Principal  
GIET ENGINEERING COLLEGE,  
NH-16, Chaitanya Knowledge City,  
RAJAHMUNDRY - 533 296.

  
HOD



# GIET ENGINEERING COLLEGE

Approved by AICTE, New Delhi/Affiliated to JNTUK, Kakinada/Accredited by NAAC  
NH-16, Chaitanya Knowledge City, GIET Campus, Rajamahendravaram-533296, AP, India.  
Phone: 96529 29111, Website: [www.gietec.ac.in](http://www.gietec.ac.in), Email: [principalgec@giet.ac.in](mailto:principalgec@giet.ac.in)

## CERTIFICATE

Certified that Mr./Ms. VENKAT PAUL

bearing the PIN 18MU5A0301 studying IV B.Tech./MBA in the

department of MECHANICAL ENG has attended the add-on/certificate course on

REVIT

from 09-02-2021 to

22-02-2021 during the academic year 2020-2021. He/She is advised to

maintain the same spirit in his/her future endeavors.

*[Signature]*  
Coordinator

*[Signature]*  
HOD

*[Signature]*  
Principal  
GIET ENGINEERING COLLEGE  
NH-16, Chaitanya Knowledge City,  
RAJAHMUNDRY-533 296.

*[Signature]*  
Principal



# GIET ENGINEERING COLLEGE

Approved by AICTE, New Delhi/Affiliated to JNTUK, Kakinada/Accredited by NAAC  
NH-16, Chaitanya Knowledge City, GIET Campus, Rajamahendravaram-533296, AP, India.  
Phone: 96529 29111, Website: [www.gietec.ac.in](http://www.gietec.ac.in), Email: [principalgec@giet.ac.in](mailto:principalgec@giet.ac.in)

## CERTIFICATE

Certified that Mr./Ms. CHENNAMSETTI AJAY RATU

bearing the PIN 17791A0301 studying IV B.Tech./MBA in the

department of MECHANICAL ENGG has attended the add-on/certificate course on

REVIT from 09-02-2021 to

22-02-2021 during the academic year 2020-2021. He/She is advised to

maintain the same spirit in his/her future endeavors.

*M. Jay*  
Coordinator

*Principa*  
HOD

*Principal*  
Principal  
GIET ENGINEERING COLLEGE  
NH-16, Chaitanya Knowledge City,  
RAJAHMUNDRY-533 296.

*Principal*  
Principal



# GIET ENGINEERING COLLEGE

Approved by AICTE, New Delhi/Affiliated to JNTUK, Kakinada/Accredited by NAAC  
NH-16, Chaitanya Knowledge City, GIET Campus, Rajamahendravaram-533296, AP, India.  
Phone: 96529.29111, Website: [www.gietec.ac.in](http://www.gietec.ac.in), Email: [principalgec@giet.ac.in](mailto:principalgec@giet.ac.in)

## CERTIFICATE

Certified that Mr./Ms. DANDU MAHESH

bearing the PIN 17791A0303 studying IV B.Tech./MBA in the

department of MECHANICAL ENGG has attended the add-on/certificate course on

REVIT

from 09-02-2021 to

22-02-2021 during the academic year 2020-2021. He/She is advised to

maintain the same spirit in his/her future endeavors.

*[Signature]*  
Coordinator

*[Signature]*  
HOD

*[Signature]*  
Principal  
GIET ENGINEERING COLLEGE,  
NH-16, Chaitanya Knowledge City,  
RAJAHMUNDRY-533296.

*[Signature]*  
Principal



# GIET ENGINEERING COLLEGE

Approved by AICTE, New Delhi/Affiliated to JNTUK, Kakinada/Accredited by NAAC  
NH-16, Chaitanya Knowledge City, GIET Campus, Rajamahendravaram-533296, AP, India.  
Phone: 96529 29111, Website: [www.gietec.ac.in](http://www.gietec.ac.in), Email: [principalgec@giet.ac.in](mailto:principalgec@giet.ac.in)

## CERTIFICATE

Certified that Mr./Ms. POLISETTI TARUN

bearing the PIN 17791A0315 studying IV B.Tech./MBA in the

department of MECHANICAL ENG has attended the add-on/certificate course on

REVIT from 09-02-2021 to 22-02-2021 during the academic year 2020-2021. He/She is advised to

maintain the same spirit in his/her future endeavors.

*[Signature]*  
Coordinator

*[Signature]*  
HOD

*[Signature]*  
Principal  
GIET ENGINEERING COLLEGE  
NH-16, Chaitanya Knowledge City,  
RAJAHMUNDRY-533 296.

*[Signature]*  
Principal



# GIET ENGINEERING COLLEGE

Approved by AICTE, New Delhi/Affiliated to JNTUK, Kakinada/Accredited by NAAC  
NH-16, Chaitanya Knowledge City, GIET Campus, Rajamahendravaram-533296, AP, India.  
Phone: 96529 29111, Website: [www.gietec.ac.in](http://www.gietec.ac.in), Email: [principalgec@giet.ac.in](mailto:principalgec@giet.ac.in)

## CERTIFICATE

Certified that Mr./Ms. BADDI SRINU

bearing the PIN 18795A0304 studying IV B.Tech./MBA in the  
department of MECHANICAL ENGG has attended the add-on/certificate course on

REVT from 09-02-2021 to  
22-02-2021 during the academic year 2020-2021. He/She is advised to

maintain the same spirit in his/her future endeavors.

*[Signature]*  
Coordinator

*[Signature]*  
HOD

*[Signature]*  
Principal  
GIET ENGINEERING COLLEGE  
NH-16, Chaitanya Knowledge City,  
RAJAHMUNDRY-533 296.

*[Signature]*  
Principal



**Organising Committee**

**Chief Patron**

Shri. KVV Satyanarayana Raju  
Chairman, Chaitanya Group

**Patrons**

Shri. K. Sasi Kiran Varma  
Vice-chairman, Chaitanya Group  
Smt. K. V. V. Lakshmi  
Executive Director, Chaitanya Group

**Co-Patrons**

Dr. D. L. N. Raju  
CEO, Chaitanya Group  
P. Subba Raju  
General Manager, GIET Institutions

**Chairperson**

Dr.T.Vamsee Kiran  
Principal, GIET Engineering College

**Convener**

Mr.AMN Kashyap,  
Assistant Professor,  
Department of civil Engineering  
Mobile No: 9491728149  
Email id:civil.gec@giet.ac.in

**Co-ordinator**

Ms. G P Swathi  
Assistant Professor,  
Department of civil Engineering  
Email:gpswathi899@gmail.com

**A Two Week Add on Program on  
"REVIT"**

**REGISTRATION FORM**

1. Name of the Participant:
2. Class:
3. Roll Number:
4. Academic Year:
5. Branch:
6. Phone Number:
7. Email ID:
8. Address for Communication:
9. Signature of Participant:
10. Signature of class teacher:
11. Remarks (if any)

Date:

Station:

  
Principal  
GIET ENGINEERING COLLEGE,  
NH-16, Chaitanya Knowledge City,  
RAJAHMUNDRY-533 203.

HOD



**A Two Week Add on Program on  
"REVIT"**

**09.02.2021 to 23.02.2021**



**Organized**

**by**

**DEPARTMENT OF  
CIVIL ENGINEERING**

**GIET ENGINEERING COLLEGE**

(Formerly Known as Chaitanya Institute of Engineering & Technology)  
Approved by AICTE | Affiliated to JNTUK, Kakinada | Accredited by NAAC

NH-16, Chaitanya Knowledge City, GIET  
Campus, Rajamahendravaram, AP.

### About the Institute

The college is located at Chaitanya Nagar on NH-16 on the outskirts of Rajamahendravaram, in GIET campus. GIET Engineering College is an epitome of excellence in every aspect. Institute is Approved by AICTE and affiliated to JNTUK, Kakinada, Andhra Pradesh.

The Institute got accredited by NAAC. The institute offers undergraduate programs in diverse engineering streams. It features state-of-the-art facilities and a highly qualified and knowledgeable pool of staff members. Apart from the prescribed course curriculum, the institute offers an entire educational experience with greater exposure of students advanced skill learning via existing centres of excellence. It has been a pioneer in adopting several pedagogic innovations for the benefit of students. The achievements of the students of this institution in academics as well as placements stand testimony to the fact.



### About the Department

The The Department of Civil Engineering pulls out all stops to create outstanding engineers - with advanced teaching techniques and learning aids for undergraduate students. CIVIL ENGINEERING DEPARTMENT of the institute started functioning from the year 2008. Students are not only made experts in technical aspects but also in interpersonal skills, a vital ingredient to excel in the fast paced world..

To conduct Training camps and Seminars for the students to accustom them with the present modern technologies. To Create Research & Development wing to improve innovative skills of student community.

The quality teaching and guidance by highly experienced faculty members provide the best quality educational experience to the students. The regular interaction between students and faculty helps a student to apply theoretical knowledge to real-life situations. Moreover, the faculty members organize special sessions for topics such as modern technologies, Create Research & Development , etc. that assures their placement in renowned multinational companies.

### About the Program

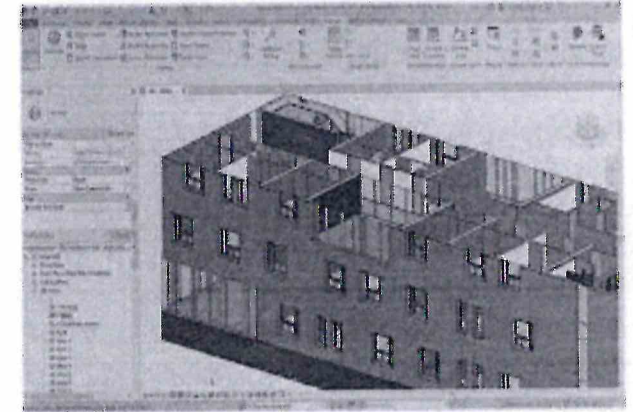

Revit is a commercial building information modeling (BIM) software by the company Autodesk. It's generally used by architects, structural engineers, mechanical, electrical, and plumbing (MEP) engineers, designers, and contractors. Autodesk Revit allows users to create, edit, and review 3D models in exceptional detail

### Resource Person

**Mr.Et. Charapani**

Assistant Professor

GIET Engineering College,  
Rajahmundry.

Mobile No:9866878484

Email id: etchakarapani253@gmail.com



# GIET ENGINEERING COLLEGE

NH - 16, Chaitanya Knowledge City, GIET Campus, Rajamahendravaram,  
Andhra Pradesh - 533296 Website: <http://www.gietec.ac.in> Email: [principalgce@giet.ac.in](mailto:principalgce@giet.ac.in)

## List of students enrolled for Add-on Certificate Program on Revit Software

S.NO	PIN NO	NAME OF THE STUDENT	PROGRAM NAME	YEAR-SEMETER	SIGNATURE OF STUDENT
1	18T91A0101	BANKAPALLI ACHYUT	B.Tech-CIVIL	III-I	B. Achyut
2	18T91A0102	BARLA VENKATA SAI PHANI VARUN	B.Tech-CIVIL	III-I	B. V. S. P. Varun
3	18T91A0103	CHEEKATLA JAGA LALITHA DEVI	B.Tech-CIVIL	III-I	C. J. L. Devi
4	18T91A0104	CHEEKATLA LOKESWARI	B.Tech-CIVIL	III-I	C. Lokeshwari
5	18T91A0105	IMMANDI UMESH VAS	B.Tech-CIVIL	III-I	I. Umesh Vas
6	18T91A0106	KAMMA HEMANTH KUMAR	B.Tech-CIVIL	III-I	K. Hemanth Kumar
7	18T91A0107	KANDREGULA SAI BHAVANI	B.Tech-CIVIL	III-I	K. Sai Bhavani
8	18T91A0108	KORUPROLU SURESH	B.Tech-CIVIL	III-I	K. Suresh
9	18T91A0109	MALLEMOGGALA UDAYA SATYA RAMA	B.Tech-CIVIL	III-I	M. U. Satya Rama
10	18T91A0110	OLETI SATISH VARMA	B.Tech-CIVIL	III-I	O. Satish Varma
11	18T91A0111	PERAPU LOKESH SAI PAVAN	B.Tech-CIVIL	III-I	P. Lokesh Sai Pavan
12	18T91A0112	SYED ABU BAKAR SIDDIQUI	B.Tech-CIVIL	III-I	S. Abu Bakar Siddiqui
13	18T91A0113	TELAGAM REDDI SUNEETHA	B.Tech-CIVIL	III-I	T. Reddi Suneetha
14	18T91A0114	VALAPATLA CHAKRAVARTHI	B.Tech-CIVIL	III-I	V. Chakravarthi
15	18T91A0115	SESETTI SADHA SUSMITHA	B.Tech-CIVIL	III-I	S. Sadha Susmitha
16	18T91A0116	MOHAMMAD SHAFIUDDIN	B.Tech-CIVIL	III-I	M. Shafiuddin
17	19T95A0101	ANUMOLU KUMARI	B.Tech-CIVIL	III-I	A. Kumari
18	19T95A0102	BASSA VEERA BABU	B.Tech-CIVIL	III-I	B. Veera Babu
19	19T95A0103	JUTHIGA REVATHI	B.Tech-CIVIL	III-I	J. Revathi
20	19T95A0104	KADIMCHARLA SURYA KOTESWARA	B.Tech-CIVIL	III-I	K. Surya Koteswara
21	19T95A0105	KANNURI CHARANDAS ARAVIND	B.Tech-CIVIL	III-I	K. Ch. Aravind
22	19T95A0106	MATCHA NAGAKUMARI	B.Tech-CIVIL	III-I	M. Nagakumari
23	19T95A0107	MEDAPATI LAVANYA	B.Tech-CIVIL	III-I	M. Lavanya
24	19T95A0108	SAMPATI SAMBASIVARAO	B.Tech-CIVIL	III-I	S. Sambasivarao
25	19T95A0109	REDDY DURGA PRASAD BABU	B.Tech-CIVIL	III-I	R. D. Prasad Babu
26	19T95A0110	VADRANAM SAI TEJA	B.Tech-CIVIL	III-I	V. Sai Teja
27	19T95A0111	KANDA NAGARAJU	B.Tech-CIVIL	III-I	K. Nagaraju
28	19T95A0112	TATIPUDI MANIKANTA	B.Tech-CIVIL	III-I	T. Manikanta
29	19T95A0113	PERALA TEJA	B.Tech-CIVIL	III-I	P. Teja

  
COORDINATOR



  
HOD

Principal  
GIET ENGINEERING COLLEGE,  
NH-16, Chaitanya Knowledge City,  
RAJAHMUNDRY - 533 296.



**GIET ENGINEERING COLLEGE**  
 NH - 16, Chaitanya Knowledge City, GIET Campus, Rajamahendravaram,  
 Andhra Pradesh - 533296 Website: <http://www.gietec.ac.in> Email: [principalgiet@giet.ac.in](mailto:principalgiet@giet.ac.in)

**DEPARTMENT OF CIVIL ENGINEERING**  
 Day wise attendance

S.NO	PIN NO	NAME OF THE STUDENT	15.02.2021	16.02.2021	17.02.2021	18.02.2021	19.02.2021	20.02.2021	22.02.2021	23.02.2021	24.02.2021	25.02.2021	26.02.2021	27.02.2021
1	17T91A0101	CHELLURI VASANTHA SIDDU	P	A	P	P	P	P	P	P	P	P	P	P
2	17T91A0102	PENUMAKA MAHENDRA SATYA SAI	P	P	P	P	P	P	P	P	P	P	P	P
3	17T91A0103	SURYANARAYANA	P	P	P	P	P	P	P	P	P	P	P	P
4	17T91A0104	KOSURI RAKESH SURYA TEJA VARMA	P	P	P	P	P	P	P	P	P	P	P	P
5	17T91A0105	MAJJI SURESH	P	P	P	P	P	P	P	P	P	P	P	P
6	17T91A0106	GEDDAM KIRAN	P	P	P	P	P	P	P	P	P	P	P	P
7	17T91A0107	TELAGAMREDDI GOWTHAMI	P	P	P	P	P	P	P	P	P	P	P	P
8	17T91A0108	BOMMULA AJESH KUMAR	P	P	P	P	P	P	P	P	P	P	P	P
9	17T91A0109	KATARI SASIVARMA	P	P	P	P	P	P	P	P	P	P	P	P
10	17T91A0110	KANUPARTHI PAVAN SAI	P	P	P	P	P	P	P	P	P	P	P	P
11	18T95A0101	KUMAR	P	P	P	P	P	P	P	P	P	P	P	P
12	18T95A0102	ALTHI DEVENDRA	P	P	P	P	P	P	P	P	P	P	P	P
13	18T95A0103	ANALA SHIVANI	P	P	P	P	P	P	P	P	P	P	P	P
14	18T95A0104	BISSATI SRIDATTA CHETAN	P	P	P	P	P	P	P	P	P	P	P	P
15	18T95A0105	CHITAKANA HARSHA VARDHANI	P	P	P	P	P	P	P	P	P	P	P	P
16	18T95A0106	GADAM SRI AMBIKA AVINASH	P	P	P	P	P	P	P	P	P	P	P	P
17	18T95A0107	GANASULA PRASANTH	P	P	P	P	P	P	P	P	P	P	P	P
18	18T95A0108	GELLA NARENDRA	P	P	P	P	P	P	P	P	P	P	P	P
19	18T95A0109	GRANDHI SRI VENKATA HARI SAI	P	P	P	P	P	P	P	P	P	P	P	P
20	18T95A0110	GUDAE GEETHA VASUDHA	P	P	P	P	P	P	P	P	P	P	P	P
21	18T95A0111	JEELAKARRA VEERENDRA	P	P	P	P	P	P	P	P	P	P	P	P
22	18T95A0112	KADA MANIKANTA	P	P	P	P	P	P	P	P	P	P	P	P
23	18T95A0113	MAMIDISETTI PRASANTH	P	P	P	P	P	P	P	P	P	P	P	P
24	18T95A0114	MARISETTI SAI SRI	P	P	P	P	P	P	P	P	P	P	P	P
25	18T95A0115	MULAPARTHI ANNAVARAM	P	P	P	P	P	P	P	P	P	P	P	P
26	18T95A0116	NAINI RAJANI	P	P	P	P	P	P	P	P	P	P	P	P
27	18T95A0117	NAINI SAJANI	P	P	P	P	P	P	P	P	P	P	P	P
28	18T95A0118	NUNNA RAJKUMAR	P	P	P	P	P	P	P	P	P	P	P	P
29	18T95A0119	PERICHARLA HARSHITH VARMA	P	P	P	P	P	P	P	P	P	P	P	P
30	18T95A0120	PILLA DURGA PRASAD	P	P	P	P	P	P	P	P	P	P	P	P
31	18T95A0121	PUSULURI CHANDU	P	P	P	P	P	P	P	P	P	P	P	P
32	18T95A0122	RUDRAPATI NAGA RAJU	P	P	P	P	P	P	P	P	P	P	P	P

Principal  
 GIET ENGINEERING COLLEGE,  
 NH-16, Chaitanya Knowledge City,  
 RAJAMUNDY-533 296.

33	18T95A0123	SAPIREDDY GOPALAKRISHNA	P	P	P	P	P	P	P	P	P	P	P	P
34	18T95A0124	SHEIK NOOR MOHAMMAD	P	P	P	P	P	P	P	P	P	P	P	P
35	18T95A0125	YEKULA VIJAY VARDHAN GOWD	P	P	P	P	P	P	P	P	P	P	P	P
36	18T95A0126	KODIDALA RAMESH BABU	P	P	P	P	P	P	P	P	P	P	P	P

  
Coordinator

  
Principal  
GIET ENGINEERING COLLEGE,  
NH-16, Chaitanya Knowledge City,  
RAJAHMUNDRY - 533 296.

  
HOD



# GIET ENGINEERING COLLEGE

NH - 16, Chaitanya Knowledge City, GIET Campus, Rajamahendravaram,  
Andhra Pradesh - 533296 Website: <http://www.gietec.ac.in> Email: [principalgec@giet.ac.in](mailto:principalgec@giet.ac.in)

Date: 24.02.2021

## PROGRAM REPORT

**Name of the Program** : "A Two-Week Certificate Program on REVIT Software"  
**Date/Duration** : 09.02.2021 to 22.02.2021 (Two Week).  
**Resource Person** : Mr. E T Chakarpani,  
Head of the Department,  
CE, GIET ENGINEERING COLLEGE,  
Rajahmundry, A.P.

Phone: 9866878484

Mail: [civil.gec@giet.ac.in](mailto:civil.gec@giet.ac.in)

**Name of the Coordinator** : Ms. G P Swathi, Assistant Professor, CE.

**No of the Participants** : 29

**Program Objective** :

- Learn basic to advanced REVIT
- The best courses for building a great profiles for higher study and jobs
- Participants can apply for LOR after the program
- Allows to draw and edit 2D and 3D designs
- Minimize human errors and helps the users to bring imagination to animation.

**Topics Covered**

: The following topics are covered

- Introduction to REVIT
- Introduction to 3D and 3D solids

Principal  
GIET ENGINEERING COLLEGE  
NH-16, Chaitanya Knowledge City,  
RAJAHMUNDRY-533 296.  
Extrude, loft, press

Principal  
GIET ENGINEERING COLLEGE,  
NH-16, Chaitanya Knowledge City,  
RAJAHMUNDRY-533 296.



# GIET ENGINEERING COLLEGE

Approved by AICTE, New Delhi/Affiliated to JNTUK, Kakinada/Accredited by NAAC  
NH-16, Chaitanya Knowledge City, GIET Campus, Rajamahendravaram-533296, AP, India.  
Phone: 96529 29111, Website: [www.gietec.ac.in](http://www.gietec.ac.in), Email: [principalgec@giet.ac.in](mailto:principalgec@giet.ac.in)

## CERTIFICATE

Certified that Mr./Ms. KORUPROLU SURESH

bearing the PIN 18791A0108 studying III B.Tech./MBA in the  
department of CIVIL

has attended the add-on/certificate course on

REVIT SOFTWARE

from 9/2/2021 to



23/2/2021 during the academic year 2020-2021

. He/ She is advised to

maintain the same spirit in his/her future endeavors.

  
Coordinator

  
HOD

  
Principal  
GIET ENGINEERING COLLEGE,  
NH-16, Chaitanya Knowledge City,  
RAJAHMUNDRY-533 296.   
Principal



# GIET ENGINEERING COLLEGE

Approved by AICTE, New Delhi/Affiliated to JNTUK, Kakinada/Accredited by NAAC  
NH-16, Chaitanya Knowledge City, GIET Campus, Rajamahendravaram-533296, AP, India.  
Phone: 96529 29111, Website: [www.gietec.ac.in](http://www.gietec.ac.in), Email: [principalgec@giet.ac.in](mailto:principalgec@giet.ac.in)

## CERTIFICATE

Certified that Mr./Ms. CHEEKATLA LOKESWARJ

bearing the PIN 18T91A0104 studying III B.Tech./MBA in the  
department of CIVIL

has attended the add-on/certificate course on

REVIT SOFTWARE

from 09/2/2021 to

23/2/2021 during the academic year 2020-2021

. He/ She is advised to

maintain the same spirit in his/her future endeavors.

  
Coordinator

  
HOD

  
Principal  
GIET ENGINEERING COLLEGE,  
NH-16, Chaitanya Knowledge City,  
RAJAMUNDURY-533 296.

  
Principal





# GIET ENGINEERING COLLEGE

Approved by AICTE, New Delhi/Affiliated to JNTUK, Kakinada/Accredited by NAAC  
NH-16, Chaitanya Knowledge City, GIET Campus, Rajamahendravaram-533296, AP, India.  
Phone: 96529 29111, Website: [www.gietec.ac.in](http://www.gietec.ac.in), Email: [principalgec@giet.ac.in](mailto:principalgec@giet.ac.in)

## CERTIFICATE

Certified that Mr./Ms. IMMANDI UMESH VAS

bearing the PIN 18791A0105 studying III B.Tech./MBA in the  
department of CIVIL

has attended the add-on/certificate course on

REVIT SOFTWARE

from 9/2/2021 to

23/2/2021 during the academic year 2020-2021

. He/ She is advised to

maintain the same spirit in his/her future endeavors.

  
Coordinator

  
HOD

  
Principal  
GIET ENGINEERING COLLEGE,  
NH-16, Chaitanya Knowledge City,  
RAJAHMUNDRY-533 296.

  
Principal



# GIET ENGINEERING COLLEGE

Approved by AICTE, New Delhi/Affiliated to JNTUK, Kakinada/Accredited by NAAC  
NH-16, Chaitanya Knowledge City, GIET Campus, Rajamahendravaram-533296, AP, India.  
Phone: 96529 29111, Website: [www.gietec.ac.in](http://www.gietec.ac.in), Email: [principalgec@giet.ac.in](mailto:principalgec@giet.ac.in)

## CERTIFICATE

Certified that Mr./Ms. ANUMOLU KUMARI

bearing the PIN 19795A0101 studying III B.Tech./MBA in the  
department of CIVIL

has attended the add-on/certificate course on

REVIT SOFTWARE

from 9/2/2021 to



23/2/2021 during the academic year 2020-2021

. He/ She is advised to

maintain the same spirit in his/her future endeavors.

  
Coordinator

  
HOD

  
Principal  
GIET ENGINEERING COLLEGE,  
NH-16, Chaitanya Knowledge City,  
RAJAHMUNDRY-533 296.   
Principal



# GIET ENGINEERING COLLEGE

Approved by AICTE, New Delhi/Affiliated to JNTUK, Kakinada/Accredited by NAAC  
NH-16, Chaitanya Knowledge City, GIET Campus, Rajamahendravaram-533296, AP, India.  
Phone: 96529 29111, Website: [www.gietec.ac.in](http://www.gietec.ac.in), Email: [principalgec@giet.ac.in](mailto:principalgec@giet.ac.in)

## CERTIFICATE

Certified that Mr./Ms. MEDAPATI LAVANYA

bearing the PIN 19795A0107 studying III B.Tech./MBA in the  
department of CIVIL

has attended the add-on/certificate course on

REVIT SOFTWARE

from 9/2/2021 to

23/2/2021 during the academic year 2020-2021

. He/ She is advised to

maintain the same spirit in his/her future endeavors.

  
Coordinator

  
HOD

  
Principal  
GIET ENGINEERING COLLEGE,  
NH-16, Chaitanya Knowledge City,  
RAJAHMUNDRY-533 296.

  
Principal

20-11

**Organising Committee**

**Chief Patron**

Shri. KVV Satyanarayana Raju  
Chairman, Chaitanya Group

**Patrons**

Shri. K. Sasi Kiran Varma  
Vice-chairman, Chaitanya Group  
Smt. K. V. V. Lakshmi  
Executive Director, Chaitanya Group

**Co-Patrons**

Dr. D. L. N. Raju  
CEO, Chaitanya Group  
P. Subba Raju  
General Manager, GIET Institutions

**Chairperson**

Dr. T. Vamsee Kiran  
Principal, GIET Engineering College

**Convener**

Mr. K. Nagaraju,  
Head of the department,  
Department of CSE  
Mobile No: 9989442311  
Email: [nagaraju@giet.ac.in](mailto:nagaraju@giet.ac.in)

**Co-ordinator**

Mrs. T. Meenakshi,  
Assistant Professor,  
Department of CSE  
Mobile No: 9948547982  
Email id: [meenakshi@giet.ac.in](mailto:meenakshi@giet.ac.in)

**A Two Week Add on Program on  
"Advanced Python Programming"  
REGISTRATION FORM**

1. Name of the Participant:
2. Class:
3. Roll Number:
4. Academic Year:
5. Branch:
6. Phone Number:
7. Email ID:
8. Address for Communication:
9. Signature of Participant:
10. Signature of class teacher:
11. Remarks (if any)

Date:  
Station:

*(Handwritten Signature)*

**Principal  
GIET ENGINEERING COLLEGE,  
NH-16, Chaitanya Knowledge City,  
RAJAHMUNDRY-533 296.**

HOD



**A Two Week Add on Program on  
"Advanced Python Programming"  
11.02.2021 to 24.02.2021**

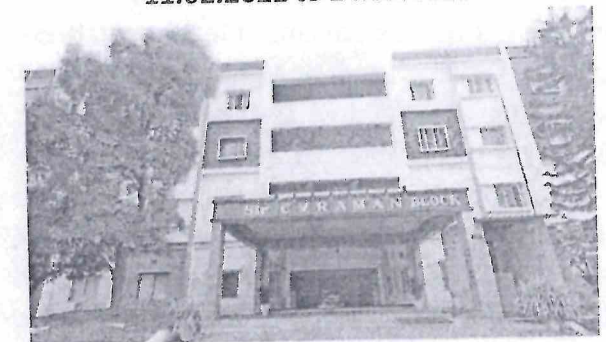

**Organized  
by  
DEPARTMENT OF  
COMPUTER SCIENCE AND ENGINEERING  
GIET ENGINEERING COLLEGE**  
(Formerly Known as Chaitanya Institute of Engineering & Technology)  
Approved by AICTE | Affiliated to JNTUK, Kakinada | Accredited by MAAC

NH-16, Chaitanya Knowledge City, GIET  
Campus, Rajamahendravaram, AP.

## About the Institute

The college is located at Chaitanya Nagar on NH-16 on the outskirts of Rajamahendravaram, in GIET campus. GIET Engineering College is an epitome of excellence in every aspect. Institute is Approved by AICTE and affiliated to JNTUK, Kakinada, Andhra Pradesh.

The Institute got accredited by NAAC. The institute offers undergraduate programs in diverse engineering streams. It features state-of-the-art facilities and a highly qualified and knowledgeable pool of staff members. apart from the prescribed course curriculum, the institute offers an entire educational experience with greater exposure of students advanced skill learning via existing centres of excellence. It has been a pioneer in adopting several pedagogic innovations for the benefit of students. The achievements of the students of this institution in academics as well as placements stand testimony to the fact.



## About the Department

Department of COMPUTER SCIENCE AND ENGINEERING started in the year of 2005. It is offering graduate program B.Tech. Department has well qualified and dedicated faculty members.

Department has produced good number of graduates well settled in industry and some are also involved in research activities.

The Department provides state-of-the-art computing facilities to the students enabling them to stay a step ahead. The courses are designed to combine rigorous academic study and exhaustive practical exposure for students with in-depth lab-oriented courses, projects, and internships.

The Department hosts a number of workshops and student managed symposiums. The department also encourages innovative projects and Internships in various interrelated domains. The department has high-end computer labs as well as the CM Skill Excellence Centre. Because the current industry requires a student with exposure and skill set in Data Sciences, Machine Learning, Web Development, and so on, the department-driven programme is designed to prepare students for the workforce.

## About the Program



Advance Python Applications like Download Manager using advance concepts to make you a professional programmer able to get good jobs in this field. Python course is for those who have learnt some Basics Python and want to deepen the knowledge of Python. You will never be able to succeed in Programming Field until you learnt

Advance concepts so that is why i have made this course to make you guys capable to design your own Applications and be a successful Programmer. Just by sticking on the Basics concept will not do the job. You have to learn advance concepts to be a Professional so and become a Pro Programmer...

### Resource Person

**Ms B. Sai Deepthi,**

Assistant Professor

GIET Engineering College,

Rajahmundry.

Mobile No: 9866440402

Email: [saidepthibcse@giet.ac.in](mailto:saidepthibcse@giet.ac.in)



## GIET ENGINEERING COLLEGE

NH - 16, Chaitanya Knowledge City, GIET Campus, Rajamahendravaram,  
Andhra Pradesh - 533296 Website: <http://www.gietec.ac.in> Email: [principalgco@giet.ac.in](mailto:principalgco@giet.ac.in)

### List of students enrolled for A Certificate Program on Advanced Python programming

S.NO	PIN NO	NAME OF THE STUDENT	PROGRAM NAME	YEAR-SEMETER	SIGNATURE OF STUDENT
1	18T91A0530	MOTHEENI LAXMAN PRADEEP	B.Tech-CSE	II-II	Praadeep
2	18T91A0546	SISTA RAMAKRISHNA SAI PAVAN	B.Tech-CSE	II-II	S. Rama Krishna Sai Pavan
3	19T91A0501	KATRAGADDA SRI RAHITHA	B.Tech-CSE	II-II	K. Sri Rahitha
4	19T91A0502	KADAMBALA DURGAPRASAD	B.Tech-CSE	II-II	K. Durga Prasad
5	19T91A0503	REDDY ANUSHA	B.Tech-CSE	II-II	Reddy Anusha
6	19T91A0504	CHEVVAKULA SUJITHA	B.Tech-CSE	II-II	C. Sujitha
7	19T91A0505	DUGGINENI SESHARAO	B.Tech-CSE	II-II	D. Seshu Rao
8	19T91A0506	GHANTA SWETHA	B.Tech-CSE	II-II	G. Swetha
9	19T91A0507	SEERAM MEHAR BABA	B.Tech-CSE	II-II	S. Mehar Babar
	19T91A0508	PASUPULETI VINAY	B.Tech-CSE	II-II	P. Vinay
11	19T91A0509	GUTHULA VYSHNAVI	B.Tech-CSE	II-II	G. Vishnavi
12	19T91A0510	VEERAVILLI SATYA RAJESH	B.Tech-CSE	II-II	V. Satya Rajesh
13	19T91A0511	NAGIREDDY VEERA VENKATA SAI TEJA	B.Tech-CSE	II-II	Nagi Reddy
14	19T91A0512	KOMALI SAI SUPRAJA	B.Tech-CSE	II-II	K. Supraja
15	19T91A0513	DANDU SAI SATHVIKA	B.Tech-CSE	II-II	D. Sai Sathvika
16	19T91A0514	MAILAVARAPU VENKATA PRASAD	B.Tech-CSE	II-II	M. Venkate Prasad
17	19T91A0515	ADAPA SRILAKSHMI PRASANNA	B.Tech-CSE	II-II	A. Sri Lakshmi Prasanna
18	19T91A0516	ALLU HANSHIKA REDDY	B.Tech-CSE	II-II	A. H Reddy
19	19T91A0517	YERAPOTHINI JANA PRIYA DEVI	B.Tech-CSE	II-II	S.R. Sri Srinivas
20	19T91A0518	SAPPA ROHITH SAI SRINIVAS	B.Tech-CSE	II-II	S.R. Sai Srinivas
21	19T91A0519	KONDAPALLI H V V SATYASAI KUMARA	B.Tech-CSE	II-II	K.V.V. Kumara
22	19T91A0520	VADDI B V S D PHANI PRAKASH	B.Tech-CSE	II-II	V.B.V.S PRARASH
23	19T91A0521	GODASI VENKATA SAI SUBRAHMANYAM	B.Tech-CSE	II-II	SUBRAHMANYAM
24	19T91A0522	YEDIDI VAMSI SATYA KRISHNA	B.Tech-CSE	II-II	Y. vamsi satya
25	19T91A0523	MOYILLA GANGA DEVI	B.Tech-CSE	II-II	M. Ganga Devi
26	19T91A0524	DARAPUREDDY LAKSHMI ROHIT KALYAN	B.Tech-CSE	II-II	D. Sravan Kumar
27	19T91A0525	DIGUMARTHI SRAVAN KUMAR	B.Tech-CSE	II-II	V.N. Venkatesh Prasad
28	19T91A0526	VETSA NAGA VENKATA PRAVEEN	B.Tech-CSE	II-II	manikanta
29	19T91A0528	KOLLU LEELA SRI SAI MANIKANTA	B.Tech-CSE	II-II	K.T. Bhaskar Chowdary
30	19T91A0529	KATURI JAYA BHASKAR CHOWDARY	B.Tech-CSE	II-II	V. Tirumala
31	19T91A0530	VEESAM TIRUMALA	B.Tech-CSE	II-II	M.S. Varma
32	19T91A0531	MANDAPALLI SUNIL VARMA	B.Tech-CSE	II-II	U.P. Pushpanjali
33	19T91A0532	IJJANA RATNA PUSHPANJALI	B.Tech-CSE	II-II	K. Jagan
34	19T91A0533	KUNUKU PAVANI	B.Tech-CSE	II-II	Nagalla V.V. Babu
35	19T91A0534	NAGALLA VIJAY VENKOJI BABU	B.Tech-CSE	II-II	J.T. Kiran
36	19T91A0535	JAKKA HARI KISHORE	B.Tech-CSE	II-II	B. Praveen
37	19T91A0536	BOLISETTI PRASANTHI	B.Tech-CSE	II-II	J.P.N.V. Ajay Kumar
38	19T91A0537	JAGGINA PARTHA NAGA VEERA AJAY KUMAR	B.Tech-CSE	II-II	P. Siva Kumar
39	19T91A0538	PATHI SIVA KUMAR	B.Tech-CSE	II-II	Sudhakar
40	19T91A0539	JANAPAREDDY MOHAN SAI KUMAR	B.Tech-CSE	II-II	Xh. Sai Manikanta
41	19T91A0540	NAGAVARAPU SAI MANIKANTA	B.Tech-CSE	II-II	

Principal  
GIET ENGINEERING COLLEGE  
NH-16, Chaitanya Knowledge City,  
RAJAHMUNDRY-533 296.

(2020-21)  
2-25/11

42	19T91A0541	JAMPANA MAHESH	B.Tech-CSE	II-II	J. Mahesh
43	19T91A0542	JOGA SANTOSH KUMAR	B.Tech-CSE	II-II	J. Santosh Kumar
44	19T91A0543	PERABATHULA SOWMYA	B.Tech-CSE	II-II	P. Sowmya
45	19T91A0544	PATHIWADA NAGA VENKATA SANJAY KUMAR	B.Tech-CSE	II-II	T. Uttej Sagar
46	19T91A0545	TADEPALLI UTTEJSAGAR	B.Tech-CSE	II-II	T. Uttej Sagar
47	19T91A0546	KONDURU AKSHAY	B.Tech-CSE	II-II	K. AKSHAY
48	19T91A0547	GONTHINA ATCHYUTHA MAHESH	B.Tech-CSE	II-II	A. Chyuth
49	19T91A0548	MALLEPULA BHARGAV	B.Tech-CSE	II-II	M. BHARGAV
50	19T91A0549	CHITROJU KUMARTEJA	B.Tech-CSE	II-II	Ch. Kumar Teja
51	19T91A0550	TEKI VIJAYA LAKSHMI	B.Tech-CSE	II-II	Teji. Murthy
52	19T91A0551	POSAPALLI DHARMARAJU	B.Tech-CSE	II-II	P. Dharmaraju
53	19T91A0552	TURAGA PRAVEEN SHARMA	B.Tech-CSE	II-II	T. Praveen Sharma
54	19T91A0553	TIRUMALASETTI ESWAR ANAND KAPARDHI	B.Tech-CSE	II-II	T. E.A. Kapardhi
55	19T91A0554	PARASA SATYA JAYA KRISHNA	B.Tech-CSE	II-II	S. Satya Krishna
56	19T91A0555	PENTYALA SUDHEER	B.Tech-CSE	II-II	P. Sudheer
57	19T91A0556	GARAPATI SUVARNA KUMARI	B.Tech-CSE	II-II	S. Kumari
58	19T91A0557	SURYA TEJA TERLI	B.Tech-CSE	II-II	S. Teja Terli
59	19T91A0558	CHERUVU SREE SURYA SHANMUKHA MEENAKSI	B.Tech-CSE	II-II	S. Shanmukha Meenaksi
60	19T91A0559	ADABALA ACHYUTH	B.Tech-CSE	II-II	A. Achyuth
61	19T91A0560	SADU DILEEP KUMAR	B.Tech-CSE	II-II	Dileep Kumar
62	19T91A0561	CHINTA SAI SRINIVASA RAO	B.Tech-CSE	II-II	C. Srinivasa Rao
63	19T91A0562	ARIGI VIJAY BABU	B.Tech-CSE	II-II	Arigi Vijay Babu
64	19T91A0563	PHANI BHUSHAN BOZZAM	B.Tech-CSE	II-II	P. Bhushan Bozzam
65	19T91A0564	RAJ JAIN	B.Tech-CSE	II-II	R. JAIN
66	20T95A0501	CHEBOLU VENKATA SAI ADITYA VARDHAN	B.Tech-CSE	II-II	Ch. Aditya Vardhan
67	20T95A0502	GODAVARTHI NARASIMHA CHOWDARY	B.Tech-CSE	II-II	G. N. Chandrabu
68	20T95A0503	GANDI SRINU	B.Tech-CSE	II-II	G. Srinu

Meenakshi  
COORDINATOR

Principal  
GIET ENGINEERING COLLEGE,  
NH-16, Chaitanya Knowledge City,  
RAJAHMUNDRY - 533 296.

HOD



(2020-21)  
2-2 Sem

## GIET ENGINEERING COLLEGE

NH - 16, Chaitanya Knowledge City, GIET Campus, Rajamahendravaram,  
Andhra Pradesh-533296 Website: <http://www.gietec.ac.in> Email: [principalgiet@giet.ac.in](mailto:principalgiet@giet.ac.in)

### DEPARTMENT OF COMPUTER SCIENCE AND ENGINEERING

#### Day wise attendance

S.NO	PIN NO	NAME OF THE STUDENT	11.02.2021	12.02.2021	13.02.2021	15.02.2021	16.02.2021	17.02.2021	18.02.2021	19.02.2021	20.02.2021	22.02.2021	23.02.2021	24.02.2021
1	18T91A0530	MOTHINENI LAXMAN PRADEEP	P	P	A	P	P	P	P	A	P	P	P	A
2	18T91A0546	SISTA RAMAKRISHNA SAI PAVAN	P	P	P	P	P	P	A	P	P	P	P	P
3	19T91A0501	KATRAGADDA SRI RAHITHA	P	P	P	P	P	P	P	P	P	A	P	P
4	19T91A0502	KADAMBALA DURGAPRASAD	P	P	P	P	A	P	P	P	P	P	P	P
5	19T91A0503	REDDY ANUSHA	P	P	P	A	P	P	P	P	P	P	P	P
6	19T91A0504	CHEVVAKULA SUJITHA	P	P	P	P	P	P	P	P	A	P	P	P
7	19T91A0505	DUGGINENT SESHARAO	P	P	P	P	P	P	P	P	P	P	P	P
8	19T91A0506	GHANTA SWETHA	P	P	P	P	P	P	P	P	P	A	P	P
9	19T91A0507	SEERAM MEHAR BABA	P	A	P	P	P	P	P	P	P	P	A	P
10	19T91A0508	PASUPULETI VINAY	P	P	P	P	P	P	P	P	P	P	P	P
11	19T91A0509	GUTHULA VYSHNAVI	P	P	P	P	A	P	P	P	P	P	P	P
12	19T91A0510	VEERAVILLI SATYA RAJESH	P	P	P	P	P	P	P	P	P	P	P	P
13	19T91A0511	NAGIREDDY VEERA VENKATA SAI TEJA	P	P	A	P	P	P	P	P	P	P	P	P
14	19T91A0512	KOMALI SAI SUPRAJA	P	P	P	P	P	P	P	P	P	P	P	A
15	19T91A0513	DANDU SAI SATHVIKA	P	P	P	P	P	A	P	P	P	P	P	P
16	19T91A0514	MAILAVARAPU VENKATA PRASAD	A	P	P	P	P	P	P	P	P	P	P	P
17	19T91A0515	ADAPA SRILAKSHMI PRASANNA	P	P	P	P	P	P	P	A	P	P	P	P
18	19T91A0516	ALLU HANSHIKA REDDY	P	P	P	P	P	P	P	P	P	P	P	P
19	19T91A0517	YERAPOTHINI JANA PRIYA DEVI	P	P	P	P	P	P	P	P	P	A	P	P
20	19T91A0518	SAPPA ROHITH SAI SRINIVAS	P	A	P	P	P	P	P	P	P	P	P	P
21	19T91A0519	KONDAPALLI H V V SATYASAI KUMARA	P	P	P	P	P	P	P	P	P	P	P	P
22	19T91A0520	VADDI B V S D PHANI PRAKASH	A	P	P	P	P	P	P	P	P	P	P	P
23	19T91A0521	GODASI VENKATA SAI SUBRAHMANYAM	P	P	P	P	P	A	P	P	P	P	P	P
24	19T91A0522	YEDIDI VAMSI SATYA KRISHNA	P	P	P	P	P	P	P	P	P	P	P	P
25	19T91A0523	MOYILLA GANGA DEVI	P	P	P	P	P	P	P	P	A	P	P	P
26	19T91A0524	D LAKSHMI ROHIT KALYAN	P	P	P	P	P	P	P	A	P	P	P	P
27	19T91A0525	DIGUMARTHI SRAVAN KUMAR	P	P	P	P	P	P	P	P	P	P	P	P
28	19T91A0526	VETSA NAGA VENKATA PRAVEEN	P	P	P	P	P	P	P	P	P	P	P	P
29	19T91A0528	KOLLU LEELA SRI SAI MANIKANTA	P	P	P	P	P	P	P	P	P	P	P	A
30	19T91A0529	KATURI JAYA BHASKAR CHOWDARY	A	P	P	P	P	P	P	P	P	P	P	P

Principal  
GIET ENGINEERING COLLEGE,  
NH-16, Chaitanya Knowledge City,  
RAJAMUNDRY-533 296.



31	19T91A0530	VEESAM TIRUMALA	P	P	P	P	A	P	P	P	P	P	P	P
32	19T91A0531	MANDAPALLI SUNIL VARMA	A	P	P	P	P	P	A	P	P	P	P	P
33	19T91A0532	IJJANA RATNA PUSHPANJALI	P	P	A	P	P	P	P	P	P	P	P	P
34	19T91A0533	KUNUKU PAVANI	P	P	P	P	P	A	P	P	P	P	P	P
35	19T91A0534	NAGALLA VIJAY VENKOJI BABU	P	P	P	P	P	P	P	P	P	A	P	P
36	19T91A0535	JAKKA HARI KISHORE	P	A	P	P	P	P	P	P	P	P	P	P
37	19T91A0536	BOLISETTI PRASANTHI	P	P	P	P	P	P	P	P	A	P	P	P
38	19T91A0537	J PARTHA NAGA VEERA AJAY KUMAR	P	P	P	P	P	P	P	P	P	P	P	P
39	19T91A0538	PATHI SIVA KUMAR	P	P	P	P	A	P	P	P	P	P	P	P
40	19T91A0539	JANAPAREDDY MOHAN SAI KUMAR	P	P	P	P	P	P	P	P	P	P	P	P
41	19T91A0540	NAGAVARAPU SAI MANIKANTA	P	P	P	A	P	P	P	P	P	P	P	P
42	19T91A0541	JAMPANA MAHESH	P	P	P	P	P	A	P	P	P	P	P	P
43	19T91A0542	JOGA SANTOSH KUMAR	A	P	P	P	P	P	P	A	P	P	P	P
44	19T91A0543	PERABATHULA SOWMYA	P	P	P	P	P	P	P	P	P	P	P	P
45	19T91A0544	P NAGA VENKATA SANJAY KUMAR	P	P	P	P	P	P	P	P	P	A	P	A
46	19T91A0545	TADEPALLI UTTEJSAGAR	P	P	P	P	P	P	P	P	P	P	P	P
47	19T91A0546	KONDURU AKSHAY	P	P	P	P	P	P	P	P	P	P	P	P
48	19T91A0547	GONTHINA ATCHYUTHA MAHESH	P	P	P	P	P	P	A	P	P	P	P	P
49	19T91A0548	MALLEPULA BHARGAV	P	P	P	P	P	P	P	P	P	A	P	P
50	19T91A0549	CHITROJU KUMARTEJA	P	P	P	P	P	P	P	P	P	P	P	P
51	19T91A0550	TEKI VIJAYA LAKSHMI	P	P	P	P	P	P	P	P	A	P	P	P
52	19T91A0551	POSAPALLI DHARMARAJU	P	A	P	P	P	P	P	P	P	P	P	P
53	19T91A0552	TURAGA PRAVEEN SHARMA	P	P	P	P	P	P	P	P	P	P	P	P
54	19T91A0553	TIRUMALASETTI ESWAR ANAND KAPARDHI	P	P	P	P	P	P	P	P	P	P	A	P
55	19T91A0554	PARASA SATYA JAYA KRISHNA	P	P	P	P	P	P	P	P	P	P	P	P
56	19T91A0555	PENTYALA SUDHEER	P	P	A	P	P	P	P	A	P	P	P	P
57	19T91A0556	GARAPATI SUVARNA KUMARI	P	P	P	P	P	P	P	P	P	P	P	P
58	19T91A0557	SUR YA TEJA TERLI	P	P	P	P	P	P	P	P	P	P	P	P
59	19T91A0558	C SREE SURYA SHANMUKHA MEENAKSHI	P	P	P	A	P	A	P	P	P	P	P	P
60	19T91A0559	ADABALA ACHYUTH	P	P	P	P	P	A	P	P	P	P	P	P
61	19T91A0560	SADU DILEEP KUMAR	P	P	P	P	P	P	P	P	P	P	A	A
62	19T91A0561	CHINTA SAI SRINIVASA RAO	P	P	P	P	P	P	P	P	P	P	P	P
63	19T91A0562	ARIGI VIJAY BABU	P	P	P	P	P	P	P	P	A	P	P	P
64	19T91A0563	PHANI BHUSHAN BOZZAM	P	P	P	P	P	P	P	P	P	P	P	P
65	19T91A0564	RAJ JAIN	P	P	P	P	P	P	A	P	P	P	P	P
66	20T95A0501	CHEBOLU VENKATA SAI ADITYA VARDHAN	P	P	P	P	P	P	P	P	P	P	P	P
67	20T95A0502	GODAVARTHI NARASIMHA CHOWDARY	P	A	P	P	P	P	P	P	P	P	P	P
68	20T95A0503	GANDI SRINU	P	P	P	A	P	P	P	P	P	P	P	P

Meenakshi  
Co-ordinator



## GIET ENGINEERING COLLEGE

NH - 16, Chaitanya Knowledge City, GIET Campus, Rajamahendravaram,  
Andhra Pradesh - 533296 Website: <http://www.gietec.ac.in> Email: [principalgec@giet.ac.in](mailto:principalgec@giet.ac.in)

---

Date: 27.02.2021

### PROGRAM REPORT

Name of the Program : "A Two-Week Certificate Program on  
Advanced Python Programming".

Date/Duration : 11.02.2021 to 24.02.2021 (Two Week).

Resource Person : Ms B. Sai Deepthi  
Assistant Professor, CSE.  
Phone: 9866440402  
Mail: [saideepthibcse@giet.ac.in](mailto:saideepthibcse@giet.ac.in)

Name of the Coordinator : Mrs. Meenakshi,  
Assistant Professor, CSE.

No of the Participants : 68

Program Objective :

- Programming tools: Microsoft VC, Git, Jupiter notebooks, pydoc
- Programming techniques: logging, testing, debugging profiling, packaging
- New techniques introduced after Python 3.8
- Details of decorators, lambdas, and comprehensions
- Why and how to use iterators and generators
- Details of advanced data structures: collections, arrays, queues, sets, dictionaries
- Network client-server: JSON, RPC, REST, and FTP
- Advanced introduction to concurrent programming: signals and timers, subprocesses, multiprocessing, threads, and concurrent futures.

  
Principal  
GIET ENGINEERING COLLEGE,  
NH-16, Chaitanya Knowledge City,  
RAJAHMUNDRY-533 296.



## GIET ENGINEERING COLLEGE

NH-16, Chaitanya Knowledge City, GIET Campus, Rajamahendravaram,  
Andhra Pradesh - 533296 Website: <http://www.gietec.ac.in> Email: [principalgec@giet.ac.in](mailto:principalgec@giet.ac.in)

---

Program Outcome : Following are the Program Outcomes:

- Apply the basics of programming in the Python language.
- Solve coding tasks related conditional execution, loops
- Solve coding tasks related to the fundamental notions and techniques used in object-oriented programming.
- Develop essential programming skills in Computer programming concepts.

*Meenakshi*  
Coordinator

  
Principal  
GIET ENGINEERING COLLEGE,  
NH-16, Chaitanya Knowledge City,  
RAJAHMUNDRY - 533 296.

  
HOD



# GIET ENGINEERING COLLEGE

Approved by AICTE, New Delhi/Affiliated to JNTUK, Kakinada/Accredited by NAAC  
NH-16, Chaitanya Knowledge City, GIET Campus, Rajamahendravaram-533296, AP, India.  
Phone: 96529 29111, Website: [www.gietec.ac.in](http://www.gietec.ac.in), Email: [principalgec@giet.ac.in](mailto:principalgec@giet.ac.in)

## CERTIFICATE

Certified that Mr./Ms. Allu Hanshika Reddy

bearing the PIN 19791A0516 studying II B.Tech./MBA in the

department of CSE has attended the add-on/certificate course on

Advanced python programming from 11-02-2021 to

24-02-2021 during the academic year 2020-2021. He/ She is advised to

maintain the same spirit in his/her future endeavors.

T. Meenakshi  
Coordinator

  
HOD

  
Principal  
GIET ENGINEERING COLLEGE  
NH-16, Chaitanya Knowledge City,  
RAJAHMUNDRY-533 296.



# GIET ENGINEERING COLLEGE

Approved by AICTE, New Delhi/Affiliated to JNTUK, Kakinada/Accredited by NAAC  
NH-16, Chaitanya Knowledge City, GIET Campus, Rajamahendravaram-533296, AP, India.  
Phone: 96529 29111, Website: [www.gietec.ac.in](http://www.gietec.ac.in), Email: [principalgec@giet.ac.in](mailto:principalgec@giet.ac.in)

## CERTIFICATE

Certified that Mr./Ms. Moyilla Ganga Devi

bearing the PIN 19791A0523 studying II B.Tech./MBA in the  
department of CSE has attended the add-on/certificate course on

Advanced python programming from 11-02-2021 to  
24-02-2021 during the academic year 2020-2021. He/ She is advised to

maintain the same spirit in his/her future endeavors.

P. Meenakshi  
Coordinator

  
HOD

  
Principal  
GIET ENGINEERING COLLEGE  
NH-16, Chaitanya Knowledge City,  
RAJAHMUNDRY-533 296.

  
Principal



# GIET ENGINEERING COLLEGE

Approved by AICTE, New Delhi/Affiliated to JNTUK, Kakinada/Accredited by NAAC  
NH-16, Chaitanya Knowledge City, GIET Campus, Rajamahendravaram-533296, AP, India.  
Phone: 96529 29111, Website: [www.gietec.ac.in](http://www.gietec.ac.in), Email: [principalgec@giet.ac.in](mailto:principalgec@giet.ac.in)

## CERTIFICATE

Certified that Mr./Ms. Pasupuleti Vinay

bearing the PIN 19791A0508 studying II B.Tech./MBA in the

department of CSE has attended the add-on/certificate course on

Advanced python programming from 11-02-2021 to

24-02-2021 during the academic year 2020-2021. He/She is advised to

maintain the same spirit in his/her future endeavors.

T. Meenaku  
Coordinator

  
HOD

  
Principal  
GIET ENGINEERING COLLEGE  
NH-16, Chaitanya Knowledge City,  
RAJAHMUNDRY-533 296.

  
Principal



# GIET ENGINEERING COLLEGE

Approved by AICTE, New Delhi/Affiliated to JNTUK, Kakinada/Accredited by NAAC  
NH-16, Chaitanya Knowledge City, GIET Campus, Rajamahendravaram-533296, AP, India.  
Phone: 96529 29111, Website: [www.gietec.ac.in](http://www.gietec.ac.in), Email: [principalgec@giet.ac.in](mailto:principalgec@giet.ac.in)

## CERTIFICATE

Certified that Mr./Ms. Reddy Anusha

bearing the PIN 19T91A0503 studying II B.Tech./MBA in the

department of CSE has attended the add-on/certificate course on

Advanced python programming from 11-02-2021 to

24-02-2021 during the academic year 2020-2021. He/ She is advised to

maintain the same spirit in his/her future endeavors.

T. Meenakshi  
Coordinator

  
HOD

  
Principal  
GIET ENGINEERING COLLEGE  
NH-16, Chaitanya Knowledge City,  
RAJAHMUNDRY-533 296.

  
Principal



# GIET ENGINEERING COLLEGE

Approved by AICTE, New Delhi/Affiliated to JNTUK, Kakinada/Accredited by NAAC  
NH-16, Chaitanya Knowledge City, GIET Campus, Rajamahendravaram-533296, AP, India.  
Phone: 96529 29111, Website: [www.gietec.ac.in](http://www.gietec.ac.in), Email: [principalgec@giet.ac.in](mailto:principalgec@giet.ac.in)

## CERTIFICATE

Certified that Mr./Ms. Komali Sai Supraja

bearing the PIN 19791A0512 studying II B.Tech./MBA in the

department of CSE has attended the add-on/certificate course on

Advanced python programming from 11-02-2021 to

24-02-2021 during the academic year 2020-2021. He/ She is advised to

maintain the same spirit in his/her future endeavors.

P. Meenakshi  
Coordinator

  
HOD

  
Principal  
GIET ENGINEERING COLLEGE  
NH-16, Chaitanya Knowledge City,  
RAJAHMUNDRY-533 296.



## Organising Committee

### Chief Patron

Shri. KVV Satyanarayana Raju  
Chairman, Chaitanya Group

### Patrons

Shri. K. Sasi Kiran Varma  
Vice-chairman, Chaitanya Group  
Smt. K. V. V. Lakshmi  
Executive Director, Chaitanya Group

### Co-Patrons

Dr. D. L. N. Raju  
CEO, Chaitanya Group  
Dr.P. Subba Raju  
General Manager, GIET Institutions

### Chairperson

Dr.S. Suryanarayana Raju  
Principal, GIET Engineering College

### Convener

Mr. B. Vamsi Krishna  
Head of the department,  
Department of Electrical and Electronics  
Engineering  
Email: [eee.gec@giet.ac.in](mailto:eee.gec@giet.ac.in)

### Co-ordinator

Mr. G. Venkateswara Rao

Assistant Professor,  
Department of Electrical and Electronics  
Engineering  
Mobile No: 9052532631  
Email id: gvr605@gmail.com

## A Two Week Certification Course on "MATLAB"

### REGISTRATION FORM

1. Name of the Participant:
2. Class:
3. Roll Number:
4. Academic Year:
5. Branch:
6. Phone Number:
7. Email ID:
8. Address for Communication:
9. Signature of Participant:
10. Signature of class teacher:
11. Remarks (if any)

Date:  
Station:

  
Principal  
GIET ENGINEERING COLLEGE,  
NH-16, Chaitanya Knowledge City,  
RAJAMAHENDRAVARAM-523 203.

HOD



## A Two Week Certification course on "MATLAB"

10.02.2021 to 24.02.2021



Organized  
by

DEPARTMENT OF  
ELECTRICAL AND ELECTRONICS ENGINEERING  
**GIET ENGINEERING COLLEGE**

(Formerly Known as Chaitanya Institute of Engineering & Technology)  
Approved by AICTE | Affiliated to JNTUK, Kakinada | Accredited by NAAC

NH-16, Chaitanya Knowledge City, GIET  
Campus, Rajamahendravaram, AP.

## About the Institute

The college is located at Chaitanya Nagar on NH-16 on the outskirts of Rajamahendravaram, in GIET campus. GIET Engineering College is an epitome of excellence in every aspect. Institute is Approved by AICTE and affiliated to JNTUK, Kakinada, Andhra Pradesh.

The Institute got accredited by NAAC. The institute offers undergraduate programs in diverse engineering streams. It features state-of-the-art facilities and a highly qualified and knowledgeable pool of staff members. apart from the prescribed course curriculum, the institute offers an entire educational experience with greater exposure of students advanced skill learning via existing centres of excellence. It has been a pioneer in adopting several pedagogic innovations for the benefit of students. The achievements of the students of this institution in academics as well as placements stand testimony to the fact.



## About the Department

The department of Electrical and Electronics Engineering was established in the year 2009 with an initial intake of 60 students. The UG program of the department of Electrical and Electronics Engineering imparts solid technical background and research capabilities among the students which help them to excel in their respective fields.

It has an array of courses for students to choose from and study such as Electrical and Electronics Engineering ,Electronic devices, Power Systems, Electrical Machines, Control Systems Microcontroller, electrical circuit analysis, Power systems operations and controlling, Digital Electronics, Digital Signal Processing, Digital Control Systems, Electro Static Field, Utilization Of Electrical Energy.. and More.

The quality teaching and guidance by highly experienced faculty members provide the best quality educational experience to the students. The regular interaction between students and faculty helps a student to apply theoretical knowledge to real-life situations. Moreover, the faculty members organize special sessions for topics such as electronics, control system, networking, etc. that assures their placement in renowned multinational companies.

## About the Program

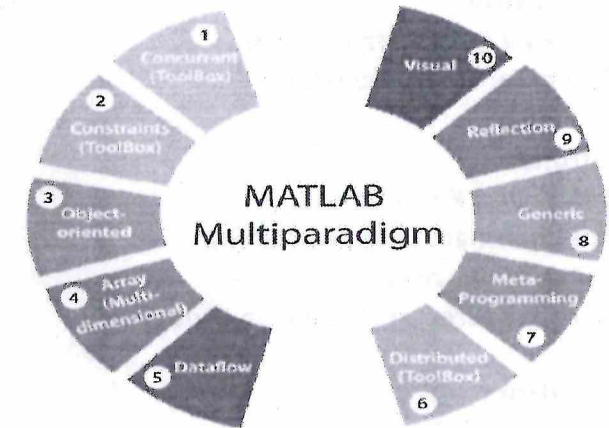

This program is designed to provide you with a comprehensive understanding of MATLAB, a high-level programming language and interactive environment for numerical computation, visualization, and programming. The program will be delivered over a period of two weeks and will cover a range of topics related to MATLAB.

### Objectives of the Program:

- To Impart the Knowledge to the students w MATLAB software
- To provide a working introduction to the M technical computing environment
- To introduce students the use of a high-level programming language, Matlab

### Resource Person

**Mr.B.Vamsi Krishna**

Asst. Professor ,EEE Dept.

GIET Engineering college

Email.id: barnikanivamsikrishna@gmail.com

Contact number:9849939383



# GIET ENGINEERING COLLEGE

NH-16, Chaitanya Knowledge City, GIET Campus, Rajamahendravaram,  
Andhra Pradesh-533296 Website: <http://www.giet.ac.in> Email: [principal@giet.ac.in](mailto:principal@giet.ac.in)

## LIST OF STUDENTS ENROLLED FOR A TWO WEEK CERTIFICATE PROGRAM ON MATLAB

S.NO	PIN NO	NAME OF THE STUDENT	PROGRAM NAME	YEAR-SEMETER	SIGNATURE OF STUDENT
1	18T95A0208	KOTLA SHIVA SANDEEP	B.Tech-EEE	III-II	K. Shiva sandeep
2	18T95A0218	TIRUMALANADHUNI PRASANTH	B.Tech-EEE	III-II	C. Anusha
3	18T91A0201	CHERUKURI ANUSHA	B.Tech-EEE	III-II	C. Anusha
4	18T91A0202	KALABATHULA SIPHORA	B.Tech-EEE	III-II	K. Siphora
5	18T91A0203	KANKATA MANIKANTA	B.Tech-EEE	III-II	K. Manikanta
6	19T95A0201	GANDIPALLI SAMUEL	B.Tech-EEE	III-II	G. Samuel
7	19T95A0202	KADALI MOHAN GANESH	B.Tech-EEE	III-II	K. Mohan Ganesh
8	19T95A0203	KARRI SOBHANBABU	B.Tech-EEE	III-II	K. Sobhanbabu
9	19T95A0204	KURMADASU RATNA BHARGAVI	B.Tech-EEE	III-II	K. Ratna Bhargavi
10	19T95A0205	MAYAKUNTLA JAYA CHANDRA	B.Tech-EEE	III-II	M. Jaya Chandra
11	19T95A0206	NAMUDURI SATYA VAIBHAV	B.Tech-EEE	III-II	N. Satya Vaibhav
12	19T95A0207	PALATHEERTHAPU SYAM RAJU	B.Tech-EEE	III-II	P. Syam Raju
13	19T95A0208	PEMMANABOYANA V V S M SURESH	B.Tech-EEE	III-II	P. Suresh
14	19T95A0209	PORIPIREDDY SHANKAR	B.Tech-EEE	III-II	P. Shankar
15	19T95A0210	UNGARALA VEERABABU	B.Tech-EEE	III-II	U. Veerababu
16	19T95A0211	CHALUMURI SEKHAR	B.Tech-EEE	III-II	Ch. Sekhar
17	19T95A0212	MELIPAKA SAI VENKATA NAGENDRA	B.Tech-EEE	III-II	M. Sai Venkata
18	19T95A0213	PAPPU RAVI	B.Tech-EEE	III-II	P. Ravi
19	19T95A0214	YELURI NAGENDRA KUMAR	B.Tech-EEE	III-II	Y. Nagendra Kumar
20	19T95A0215	CHUKKA VENKATALAKSHMI	B.Tech-EEE	III-II	C. Venkata Lakshmi
21	19T95A0216	GOLLAPALLI MANIKANTA	B.Tech-EEE	III-II	G. Manikanta
22	19T95A0217	MOILLA MANIKANTA SWAMY	B.Tech-EEE	III-II	M. Manikanta Swamy
23	19T95A0218	MUDDA NAGA SIVANARAYANA	B.Tech-EEE	III-II	M. Naga Sivanarayana
24	19T95A0219	PEDAGADA SAI TEJA GOVINDACHARI	B.Tech-EEE	III-II	P. Sai Teja
25	19T95A0221	PEKETI NAGA VARAHALU	B.Tech-EEE	III-II	P. Naga Varahalu
26	19T95A0222	JANNI M V.S. SAI KUMAR	B.Tech-EEE	III-II	J. Sai Kumar
27	19T95A0223	PALANGI PRANAY VENKAT	B.Tech-EEE	III-II	P. P. Venkata

Principal  
GIET ENGINEERING COLLEGE  
NH-16, Chaitanya Knowledge City,  
RAJAHMUNDRY-533 296.



# GIET ENGINEERING COLLEGE

NH-16, Chaitanya Knowledge City, GIET Campus, Rajamahendravaram,  
Andhra Pradesh - 533296 Website: <http://www.giet.ac.in> Email: [principal@giet.ac.in](mailto:principal@giet.ac.in)

## DEPARTMENT OF ELECTRICAL AND ELECTRONICS ENGINEERING

### Day wise attendance

S.NO	PHI NO	NAME OF THE STUDENT	10.02.21	11.02.21	12.02.21	13.02.21	15.02.21	16.02.21	17.02.21	18.02.21	19.02.21	20.02.21	22.02.21	23.02.21
1	18T95A0208	KOTLA SHIVA SANDEEP	P	P	A	P	A	P	P	P	P	P	P	P
2	18T95A0218	TIRUMALANADHUNI PRASANTH	P	P	P	P	P	P	P	P	P	P	P	P
3	18T91A0201	CHERUKURI ANUSHA	P	P	P	P	P	P	P	P	P	P	P	P
4	18T91A0202	KALABATHULA SIPHORA	P	P	P	P	P	P	P	P	P	P	P	P
5	18T91A0203	KANKATA MANIKANTA	A	P	P	P	P	P	P	P	P	P	A	P
6	19T95A0201	GANDIPALLI SAMUEL	P	A	P	P	P	P	P	A	P	P	P	P
7	19T95A0202	KADALI MOHAN GANESH	P	P	P	P	A	P	P	P	P	P	P	P
8	19T95A0203	KARRI SOBHANBABU	P	P	P	P	A	P	P	A	P	P	P	P
9	19T95A0204	KURMADASU RATNA BHARGAVI	P	P	P	P	P	A	A	P	P	P	A	P
10	19T95A0205	MAYAKUNTLA JAYA CHANDRA	P	P	P	P	A	P	P	P	P	P	A	P
11	19T95A0206	NAMUDURI SATYA VAIBHAV	P	A	P	A	P	P	P	P	P	P	P	P
12	19T95A0207	PALATHEERTHAPU SYAM RAJU	P	P	P	P	A	P	P	P	A	P	P	P
13	19T95A0208	PEMMANABOYANA V V S S M SURESH	P	P	P	P	A	A	P	P	A	P	P	P
14	19T95A0209	PORIPREDDY SHANKAR	P	P	P	P	P	P	P	A	A	P	P	P
15	19T95A0210	UNGARALA VEERABABU	P	P	P	P	P	P	P	P	P	P	P	P
16	19T95A0211	CHALUMURI SEKHAR	P	P	P	P	P	P	P	P	P	P	P	A
17	19T95A0212	MELIPAKA SAI VENKATA NAGENDRA	P	P	P	P	P	A	P	P	P	P	P	P
18	19T95A0213	PAPPU RAVI	P	P	P	P	P	P	P	P	P	P	P	P
19	19T95A0214	YELURI NAGENDRA KUMAR	A	P	P	P	P	P	P	P	P	A	P	P
20	19T95A0215	CHUKKA VENKATALAKSHMI	P	P	P	P	P	P	P	P	P	P	P	P
21	19T95A0216	GOLLAPALLI MANIKANTA	P	P	P	P	P	P	P	P	P	P	P	P
22	19T95A0217	MOILLA MANIKANTA SWAMY	P	P	A	P	A	P	P	A	P	P	P	P
23	19T95A0218	MUDDA NAGA SIVANARAYANA	P	P	P	P	A	P	P	A	P	P	P	P
24	19T95A0219	PELAGADA SAI TEJA GOVINDACHARI	P	P	P	P	P	P	P	P	P	P	P	P
25	19T95A0221	PEKETI NAGA VARAHALU	P	P	P	P	P	P	P	P	P	P	P	P
26	19T95A0222	JANNI M.V.S. SAI KUMAR	P	P	P	P	P	P	P	P	P	P	P	P
27	19T95A0223	PALANGI PRANAY VENKAT	A	A	P	P	P	A	P	P	P	P	P	A

*Get*  
Program Coordinator

Principal  
GIET ENGINEERING COLLEGE,  
NH-16, Chaitanya Knowledge City,  
RAJAHMUNDRY - 533 296.

*B. L. K.*  
HOD



## **GIET ENGINEERING COLLEGE**

NH - 16, Chaitanya Knowledge City, GIET Campus, Rajamahendravaram,  
Andhra Pradesh - 533296 Website: <http://www.gietec.ac.in> Email: [principalgiet@giet.ac.in](mailto:principalgiet@giet.ac.in)

---

Date: 25.02.2021

### **PROGRAM REPORT**

**Name of the Event: A Two Week Certificate Program on MATLAB**

**Date: 10.02.2021 to 24.02.2021**

**Resource Person: Mr. B. Vamsi Krishna**

Asst. Professor, EEE Dept. GIET Engineering college

Email.id: barnikanivamsikrishna@gmail.com

Contact number: 9849939383

**Name of the Coordinator: Mr. G. Venkateswara Rao**

**Number of students attended: 27**

**Venue: Online lab, Sir Arthur Cotton Block, GIET Engineering college**

**Objectives of the Program:**

- To Impart the Knowledge to the students with MATLAB software
- To provide a working introduction to the MATLAB technical computing environment
- To introduce students the use of a high-level programming language, Matlab

**Topics to be covered:**

- Basics of Matlab and MATLAB Compiler
- Programming with simple examples
- Discussion of Toolboxes with Applications
- Simulink and Hardware Interfacing

  
Principal  
GIET ENGINEERING COLLEGE  
NH-16, Chaitanya Knowledge City,  
RAJAHMUNDRY-533 296.

**Outcomes of the Program:**

At the end of this course, the student will be able to

1. Understand the basics of Matlab
2. Break a complex task up into smaller, simpler tasks
3. Case Study (Any two Modules)
4. Tabulate results and Analyse

  
Coordinator

  
Principal  
GIET ENGINEERING COLLEGE,  
NH-16, Chaitanya Knowledge City,  
RAJAHMUNDRY - 533 296.

  
HOD-EEE

Principal  
GIET ENGINEERING COLLEGE,  
NH-16, Chaitanya Knowledge City,  
RAJAHMUNDRY - 533 296.



# GIET ENGINEERING COLLEGE

Approved by AICTE, New Delhi/Affiliated to JNTUK, Kakinada/Accredited by NAAC  
NH-16, Chaitanya Knowledge City, GIET Campus, Rajamahendravaram-533296, AP, India.  
Phone: 96529 29111, Website: [www.gietec.ac.in](http://www.gietec.ac.in), Email: [principalgec@giet.ac.in](mailto:principalgec@giet.ac.in)

## CERTIFICATE

Certified that Mr./Ms. G. Manikanta

bearing the PIN 19T95A0916 studying III B.Tech./MBA in the  
department of EEE

has attended the add-on/certificate course on

MATLAB - Programming

from 10/9/21 to

23/9/21 during the academic year 2020-21

. He/ She is advised to

maintain the same spirit in his/her future endeavors.

G. Ilt  
Coordinator

B. Ilt  
HOD

[Signature]  
Principal  
GIET ENGINEERING COLLEGE,  
NH-16, Chaitanya Knowledge City,  
RAJAHMUNDRY-533 296. [Signature]  
Principal



# GIET ENGINEERING COLLEGE

Approved by AICTE, New Delhi/Affiliated to JNTUK, Kakinada/Accredited by NAAC  
NH-16, Chaitanya Knowledge City, GIET Campus, Rajamahendravaram-533296, AP, India.  
Phone: 96529 29111, Website: [www.gietec.ac.in](http://www.gietec.ac.in), Email: [principalgec@giet.ac.in](mailto:principalgec@giet.ac.in)

## CERTIFICATE

Certified that Mr./Ms. P. Ravi

bearing the PIN 19T95A0913 studying III B.Tech./ MBA in the  
department of EEE

has attended the add-on/certificate course on

MATLAB - Programming

from 10/9/21 to

23/2/21 during the academic year 2020-21. He/ She is advised to

maintain the same spirit in his/her future endeavors.

G. Ilet  
Coordinator

B. Ilet  
HOD

[Signature]  
Principal  
GIET ENGINEERING COLLEGE,  
NH-16, Chaitanya Knowledge City,  
RAJAHMUNDRY-533 296.





# GIET ENGINEERING COLLEGE

Approved by AICTE, New Delhi/Affiliated to JNTUK, Kakinada/Accredited by NAAC  
NH-16, Chaitanya Knowledge City, GIET Campus, Rajamahendravaram-533296, AP, India.  
Phone: 96529 29111, Website: [www.gietec.ac.in](http://www.gietec.ac.in), Email: [principalgec@giet.ac.in](mailto:principalgec@giet.ac.in)

## CERTIFICATE

Certified that Mr./Ms. P.V.V.S.S.M. Suresh

bearing the PIN 19T95A0208 studying III B.Tech./MBA in the  
department of EEE

has attended the add-on/certificate course on

MATLAB - Programming

from 10/9/21 to

23/9/21 during the academic year 2020-21

. He/ She is advised to

maintain the same spirit in his/her future endeavors.

G. Ilet  
Coordinator

B. Ilet  
HOD

[Signature]  
Principal  
GIET ENGINEERING COLLEGE,  
NH-16, Chaitanya Knowledge City,  
RAJAHMUNDRY-533 296.



# GIET ENGINEERING COLLEGE

Approved by AICTE, New Delhi/Affiliated to JNTUK, Kakinada/Accredited by NAAC  
NH-16, Chaitanya Knowledge City, GIET Campus, Rajamahendravaram-533296, AP, India.  
Phone: 96529 29111, Website: [www.gietec.ac.in](http://www.gietec.ac.in), Email: [principalgec@giet.ac.in](mailto:principalgec@giet.ac.in)

## CERTIFICATE

Certified that Mr./Ms. k. Ratna Bhargavi

bearing the PIN 19T95A0204 studying III B.Tech./ MBA in the  
department of EEE

has attended the add-on/certificate course on

MATLAB - Programming

from 10/9/21 to

23/9/21 during the academic year 2020-21

. He/ She is advised to

maintain the same spirit in his/her future endeavors.

G. Reddy  
Coordinator

B. Reddy  
HOD

[Signature]  
Principal  
GIET ENGINEERING COLLEGE,  
NH-16, Chaitanya Knowledge City,  
RAJAHMUNDRY-533 296.



# GIET ENGINEERING COLLEGE

Approved by AICTE, New Delhi/Affiliated to JNTUK, Kakinada/Accredited by NAAC  
NH-16, Chaitanya Knowledge City, GIET Campus, Rajamahendravaram-533296, AP, India.  
Phone: 96529 29111, Website: [www.gietec.ac.in](http://www.gietec.ac.in), Email: [principalgec@giet.ac.in](mailto:principalgec@giet.ac.in)

## CERTIFICATE

Certified that Mr./Ms. G. Samuel

bearing the PIN 19T95A0901 studying III B.Tech./ MBA in the  
department of EEE

has attended the add-on/certificate course on

MATLAB - Programming

from 10/9/21 to

93/9/21 during the academic year 2020-21

. He/ She is advised to

maintain the same spirit in his/her future endeavors.

  
Coordinator

  
HOD

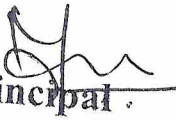
  
Principal  
GIET ENGINEERING COLLEGE  
NH-16, Chaitanya Knowledge City,  
RAJAHMUNDRY-533 296.  
  
Principal

Organising Committee

Chief Patron

Shri. KVV Satyanarayana Raju  
Chairman, Chaitanya Group

Patrons

Shri. K. Sasi Kiran Varma  
Vice-chairman, Chaitanya Group  
Smt. K. V. V. Lakshmi  
Executive Director, Chaitanya Group

Co-Patrons

Dr. D. L. N. Raju  
CEO, Chaitanya Group  
Dr.P. Subba Raju  
General Manager, GIET Institutions

Chairperson

Dr. T. Vamsee Kiran,  
Principal, GIET Engineering College

Convener

Mr. Et. Chakarapani  
Head of the department,  
Department of Civil Engineering  
Email: [civil.gec@giet.ac.in](mailto:civil.gec@giet.ac.in)

Co-ordinator

Mr .G.Anjaneyulu,  
Assistant Professor,  
Department of Civil Engineering  
Mobile No: 9359665823  
Email id: [anjaneyulu.gec@giet.ac.in](mailto:anjaneyulu.gec@giet.ac.in)

A Two Week Certification Course on  
"Ansys Software"

REGISTRATION FORM

1. Name of the Participant:
2. Class:
3. Roll Number:
4. Academic Year:
5. Branch:
6. Phone Number:
7. Email ID:
8. Address for Communication:
9. Signature of Participant:
10. Signature of class teacher:
11. Remarks (if any)

Date:  
Station:

Principal  
GIET ENGINEERING COLLEGE  
NH-16, Chaitanya Knowledge City,  
RAJAHMUNDRY-533 296.

HOD



A Two Week Certification Course on  
"Ansys Software"

15.02.2021 to 28.02.2021



Organized  
by

DEPARTMENT OF  
CIVIL ENGINEERING

**GIET ENGINEERING COLLEGE**

(Formerly Known as Chaitanya Institute of Engineering & Technology)  
Approved by AICTE | Affiliated to JNTUK, Kakinada | Accredited by NAAC

NH-16, Chaitanya Knowledge City, GIET  
Campus, Rajamahendravaram, AP.

### About the Institute

The college is located at Chaitanya Nagar on NH-16 on the outskirts of Rajamahendravaram, in GIET campus. GIET Engineering College is an epitome of excellence in every aspect. Institute is Approved by AICTE and affiliated to JNTUK, Kakinada, Andhra Pradesh.

The Institute got accredited by NAAC. The institute offers undergraduate programs in diverse engineering streams. It features state-of-the-art facilities and a highly qualified and knowledgeable pool of staff members. Apart from the prescribed course curriculum, the institute offers an entire educational experience with greater exposure of students advanced skill learning via existing centres of excellence. It has been a pioneer in adopting several pedagogic innovations for the benefit of students. The achievements of the students of this institution in academics as well as placements stand testimony to the fact.



### About the Department

The The Department of Civil Engineering pulls out all stops to create outstanding engineers - with advanced teaching techniques and learning aids for undergraduate students. CIVIL ENGINEERING DEPARTMENT of the institute started functioning from the year 2008. Students are not only made experts in technical aspects but also in interpersonal skills, a vital ingredient to excel in the fast paced world..

To conduct Training camps and Seminars for the students to accustom them with the present modern technologies. To Create Research & Development wing to improve innovative skills of student community.

The quality teaching and guidance by highly experienced faculty members provide the best quality educational experience to the students. The regular interaction between students and faculty helps a student to apply theoretical knowledge to real-life situations. Moreover, the faculty members organize special sessions for topics such as modern technologies, Create Research & Development, etc. that assures their placement in renowned multinational companies.

### About the Program

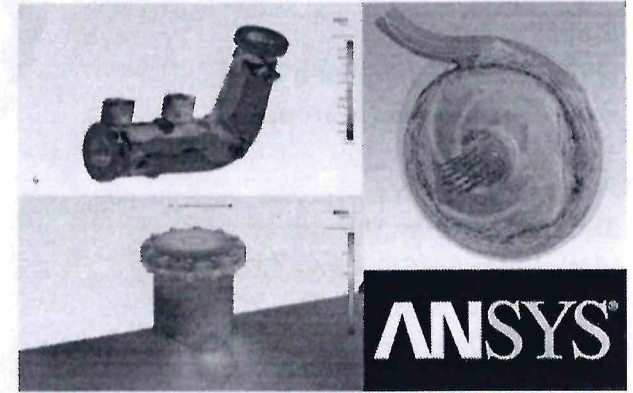

Ansys, Inc. is an American multinational company with headquarters based in Canonsburg, Pennsylvania. It develops and markets CAE / multiphysics engineering simulation software for product design, testing and verification and offers its products and services to customers worldwide.

#### Resource Person

**Ms. K. Chandrika**

Assistant Professor

GIET Engineering College,  
Rajahmundry.

Mobile No:9855588778

Email id: [kchandrika123@yahoo.com](mailto:kchandrika123@yahoo.com)



## GIET ENGINEERING COLLEGE

NH - 16, Chaitanya Knowledge City, GIET Campus, Rajamahendravaram,  
Andhra Pradesh - 533296 Website: <http://www.gietec.ac.in> Email: [principalgiet@giet.ac.in](mailto:principalgiet@giet.ac.in)

### List of students enrolled for Add-on Certificate Program on ANSYS SOFTWARE

S.NO	PIN NO	NAME OF THE STUDENT	PROGRAM NAME	YEAR-SEMETER	SIGNATURE OF STUDENT
1	17T91A0101	CHELLURI VASANTHA SIDDU	B.Tech-CIVIL	IV-I	C. SIPPU
2	17T91A0102	PENUMAKA MAHENDRA SATYA SAI	B.Tech-CIVIL	IV-I	P. Satya Sai
3	17T91A0103	JAVVADI SIVA CHAKRA SURYANARAYANA	B.Tech-CIVIL	IV-I	J.S. Suryanarayana
4	17T91A0104	KOSURI RAKESH SURYA TEJA VARMA	B.Tech-CIVIL	IV-I	R. S. Surya Teja
5	17T91A0105	MAJJI SURESH	B.Tech-CIVIL	IV-I	M. Suresh
6	17T91A0106	GEDDAM KIRAN	B.Tech-CIVIL	IV-I	G. Kiran
7	17T91A0107	TELAGAMREDDI GOWTHAMI	B.Tech-CIVIL	IV-I	T. Gowthami
8	17T91A0108	BOMMULA AJESH KUMAR	B.Tech-CIVIL	IV-I	B. Ajesh Kumar
9	17T91A0109	KATARI SASIVARMA	B.Tech-CIVIL	IV-I	K. Sasivarma
10	17T91A0110	KANUPARTHI PAVAN SAI	B.Tech-CIVIL	IV-I	K. P. Sai
11	18T95A0101	ADIREDDY BARGAVA SRI SIVA KUMAR	B.Tech-CIVIL	IV-I	S. Subrahmanya
12	18T95A0102	ALTHI DEVENDRA	B.Tech-CIVIL	IV-I	A. Devendra
13	18T95A0103	ANALA SHIVANI	B.Tech-CIVIL	IV-I	A. Shivani
14	18T95A0104	BISSATI SRIDATTA CHETAN	B.Tech-CIVIL	IV-I	B. S. CHETAN
15	18T95A0105	CHITAKANA HARSHA VARDHANI	B.Tech-CIVIL	IV-I	H. Harsha
16	18T95A0106	GADAM SRI AMBIKA AVINASH	B.Tech-CIVIL	IV-I	G. Sri Ambika Avinash
17	18T95A0107	GANASULA PRASANTH	B.Tech-CIVIL	IV-I	G. Prasanth
18	18T95A0108	GELLA NARENDRA	B.Tech-CIVIL	IV-I	G. Narendra
19	18T95A0109	GRANDHI SRI VENKATA HARI SAI	B.Tech-CIVIL	IV-I	G. Hari Sai
20	18T95A0110	GUDAE GEETHA VASUDHA	B.Tech-CIVIL	IV-I	G. Geetha Vasudha
21	18T95A0111	JEELAKARRA VEERENDRA	B.Tech-CIVIL	IV-I	J. Veerendra
22	18T95A0112	KADA MANIKANTA	B.Tech-CIVIL	IV-I	K. Manikanta
23	18T95A0113	MAMIDISETTI PRASANTH	B.Tech-CIVIL	IV-I	M. Prasanth
24	18T95A0114	MARISETTI SAI SRI	B.Tech-CIVIL	IV-I	M. Sai Sri
25	18T95A0115	MULAPARTHI ANNAVARAM	B.Tech-CIVIL	IV-I	M. ANNARAM
26	18T95A0116	NAINI RAJANI	B.Tech-CIVIL	IV-I	N. Rajani
27	18T95A0117	NAINI SAJANI	B.Tech-CIVIL	IV-I	N. Sajani
28	18T95A0118	NUNNA RAJKUMAR	B.Tech-CIVIL	IV-I	N. Rajkumar
29	18T95A0119	PERICHARLA HARSHITH VARMA	B.Tech-CIVIL	IV-I	P. Varma
30	18T95A0120	PILLA DURGA PRASAD	B.Tech-CIVIL	IV-I	P. D. Prasad
31	18T95A0121	PUSULURI CHANDU	B.Tech-CIVIL	IV-I	P. Chandu
32	18T95A0122	RUDRAPATI NAGA RAJU	B.Tech-CIVIL	IV-I	S. Gopalakrishna
33	18T95A0123	SAPIREDDY GOPALAKRISHNA	B.Tech-CIVIL	IV-I	S. Gopala Krishna
34	18T95A0124	SHEIK NOOR MOHAMMAD	B.Tech-CIVIL	IV-I	S. Mohammad
35	18T95A0125	YEKULA VIJAY VARDHAN GOWD	B.Tech-CIVIL	IV-I	V. Vardhan Gowd
36	18T95A0126	KODIDALA RAMESH BABU	B.Tech-CIVIL	IV-I	K. Ramesh Babu

COORDINATOR

HOD

Principal

GIET ENGINEERING COLLEGE,  
NH-16, Chaitanya Knowledge City,  
RAJAHMUNDRY - 533 296.



# GIET ENGINEERING COLLEGE

NH - 16, Chaitanya Knowledge City, GIET Campus, Rajamahendravaram,  
Andhra Pradesh - 533296 Website: <http://www.gietec.ac.in> Email: [principalgee@giet.ac.in](mailto:principalgee@giet.ac.in)

## DEPARTMENT OF CIVIL ENGINEERING

### Day wise attendance

S.NO	PIN NO	NAME OF THE STUDENT	15.02.2021	16.02.2021	17.02.2021	18.02.2021	19.02.2021	20.02.2021	22.02.2021	23.02.2021	24.02.2021	25.02.2021	26.02.2021	27.02.2021
1	17T91A0101	CHELLURI VASANTHA SIDDU	P	P	A	A	P	P	P	P	P	P	A	P
2	17T91A0102	PENUMAKA MAHENDRA SATYA SAI	P	P	P	D	P	P	P	P	P	P	A	P
3	17T91A0103	SURYANARAYANA	P	P	P	P	P	P	P	P	P	P	P	P
4	17T91A0104	KOSURI RAKESH SURYA TEJA VARMA	P	P	P	P	P	P	P	P	P	P	P	P
5	17T91A0105	MAJJI SURESH	A	P	P	P	P	P	P	P	P	P	P	P
6	17T91A0106	GEDDAM KIRAN	P	P	P	P	P	P	P	P	P	P	P	P
7	17T91A0107	TELAGAMREDDI GOWTHAMI	A	P	P	P	P	P	P	P	P	P	P	P
8	17T91A0108	BOMMULA AJESH KUMAR	P	P	P	P	P	P	P	P	P	P	P	P
9	17T91A0109	KATARI SASIVARMA	P	P	P	P	P	P	P	P	P	P	P	P
10	17T91A0110	KANUPARTHI PAVAN SAI	P	P	P	P	P	P	P	P	P	P	P	P
11	18T95A0101	KUMAR	P	P	P	P	P	P	P	P	P	P	P	P
12	18T95A0102	ALTHI DEVENDRA	P	P	P	P	P	P	P	P	P	P	P	P
13	18T95A0103	ANALA SHIVANI	P	P	P	P	P	P	P	P	P	P	P	P
14	18T95A0104	BISSATI SRIDATTA CHETAN	P	P	P	P	P	P	P	P	P	P	P	P
15	18T95A0105	CHITAKANA HARSHA VARDHANI	P	P	P	P	P	P	P	P	P	P	P	P
16	18T95A0106	GADAM SRI AMBIKA AVINASH	P	P	P	P	P	P	P	P	P	P	P	P
17	18T95A0107	GANASULA PRASANTH	P	P	P	P	P	P	P	P	P	P	P	P
18	18T95A0108	GELLA NARENDRA	P	P	P	P	P	P	P	P	P	P	P	P
19	18T95A0109	GRANDHI SRI VENKATA HARI SAI	P	P	P	P	P	P	P	P	P	P	P	P
20	18T95A0110	GUDAE GEETHA VASUDHA	P	P	P	P	P	P	P	P	P	P	P	P
21	18T95A0111	JEELAKARRA VEERENDRA	P	P	P	P	P	P	P	P	P	P	P	P
22	18T95A0112	KADA MANIKANTA	P	P	P	P	P	P	P	P	P	P	P	P
23	18T95A0113	MAMIDISETTI PRASANTH	P	P	P	P	P	P	P	P	P	P	P	P
24	18T95A0114	MARISETTI SAI SRI	P	A	P	P	P	P	P	P	P	P	P	P
25	18T95A0115	MULAPARTHI ANNAVARAM	P	A	P	P	P	P	P	P	P	P	P	P
26	18T95A0116	NAINI RAJANI	P	P	P	P	P	P	P	P	P	P	P	P
27	18T95A0117	NAINI SAJANI	P	P	P	P	P	P	P	P	P	P	P	P
28	18T95A0118	NUNNA RAJKUMAR	P	P	P	P	P	P	P	P	P	P	P	P
29	18T95A0119	PERICHARLA HARSHITH VARMA	P	P	P	P	P	P	P	P	P	P	P	P
30	18T95A0120	PILLA DURGA PRASAD	P	P	P	P	P	P	P	P	P	P	P	P
31	18T95A0121	PUSULURI CHANDU	A	P	P	P	P	P	P	P	P	P	P	P
32	18T95A0122	RUDRAPATI NAGA RAJU	P	P	P	P	P	P	P	P	P	P	P	P

*Handwritten signature*

Principal  
GIET ENGINEERING COLLEGE,  
NH-16, Chaitanya Knowledge City,  
RAJAHMUNDRY-533 296.

33	18T95A0123	SAPIREDDY GOPALAKRISHNA	P	A	P	P	P	P	P	P	P	P	P	P
34	18T95A0124	SHEIK NOOR MOHAMMAD	P	P	P	P	P	P	P	A	P	P	P	A
35	18T95A0125	YEKULA VIJAY VARDHAN GOWD	P	P	A	P	P	P	A	P	P	P	P	P
36	18T95A0126	KODIDALA RAMESH BABU	P	P	A	P	P	P	P	P	A	P	P	P

  
Coordinator

  
Principal  
GIET ENGINEERING COLLEGE,  
NH-16, Chaitanya Knowledge City,  
RAJAHMUNDRY - 533 296.

  
HOD





# GIET ENGINEERING COLLEGE

NH - 16, Chaitanya Knowledge City, GIET Campus, Rajamahendravaram,  
Andhra Pradesh - 533296 Website: <http://www.gietec.ac.in> Email: [principalgec@giet.ac.in](mailto:principalgec@giet.ac.in)

Date: 29.11.2021

## PROGRAM REPORT

**Name of the Program** : "A Two-Week Certificate Program on ANSYS SOFTWARE"

**Date/Duration** : 15.02.2021 to 28.02.2021 (Two Week).

**Resource Person** : CHANDRIKA KOLLURI,  
Assistant Professor,  
CE, GIET ENGINEERING COLLEGE,  
Rajahmundry, A.P

Phone: 9866878484

Mail: [civil.gec@giet.ac.in](mailto:civil.gec@giet.ac.in)

**Name of the Coordinator** : Mr. G Anjaneyulu, Assistant Professor, CE.

**No of the Participants** : 36

**Program Objective** :

- Learn basic to advanced ANSYS
- The best courses for building a great profiles for higher study and jobs
- Participants can apply for LOR after the program
- Allows to draw and edit 2D and 3D designs
- Minimize human errors and helps the users to bring imagination to animation.

**Topics Covered**

: The following topics are covered

- Introduction to ANSYS
- Introduction to 3D and 3D solids
- Extrude, loft, press

  
Principal  
GIET ENGINEERING COLLEGE,  
NH-16, Chaitanya Knowledge City,  
RAJAHMUNDRY-533 296.



## GIET ENGINEERING COLLEGE

NH - 16, Chaitanya Knowledge City, GIET Campus, Rajamahendravaram,  
Andhra Pradesh - 533296 Website: <http://www.gietec.ac.in> Email: [principalgec@giet.ac.in](mailto:principalgec@giet.ac.in)

- Dynamic UCS, selection plane

### Program Outcome :

- .Easy to zoom in and zoom out and pan to other areas of drawing
- Easy to draw objects accurately with various options to set exact size
- Can see a 3D image of drawing and can rotate it to all angles.
- Identify and solve any problems with the design before production.

  
**Coordinator**

  
Principal  
GIET ENGINEERING COLLEGE,  
NH-16, Chaitanya Knowledge City,  
RAJAHMUNDRY - 533 296.

  
**HOD**



# GIET ENGINEERING COLLEGE

Approved by AICTE, New Delhi/Affiliated to JNTUK, Kakinada/Accredited by NAAC  
NH-16, Chaitanya Knowledge City, GIET Campus, Rajamahendravaram-533296, AP, India.  
Phone: 96529 29111, Website: [www.gietec.ac.in](http://www.gietec.ac.in), Email: [principalgec@giet.ac.in](mailto:principalgec@giet.ac.in)

## CERTIFICATE

Certified that Mr./Ms. TELAGAMREDDI GOWTHAMI

bearing the PIN 19791A0107 studying IV B.Tech./ MBA in the

department of CIVIL has attended the add-on/certificate course on

ANSYS SOFTWARE

from 15/2/2021 to

28/2/2021 during the academic year 2020-2021

. He/ She is advised to

maintain the same spirit in his/her future endeavors.

  
Coordinator

  
HOD

  
Principal  
GIET ENGINEERING COLLEGE  
NH-16, Chaitanya Knowledge City,  
RAJAMUNDY-533 296.

  
Principal



# GIET ENGINEERING COLLEGE

Approved by AICTE, New Delhi/Affiliated to JNTUK, Kakinada/Accredited by NAAC  
NH-16, Chaitanya Knowledge City, GIET Campus, Rajamahendravaram-533296, AP, India.  
Phone: 96529 29111, Website: [www.gietec.ac.in](http://www.gietec.ac.in), Email: [principalgec@giet.ac.in](mailto:principalgec@giet.ac.in)

## CERTIFICATE

Certified that Mr./Ms. ALTHI DEVENDRA

bearing the PIN 18795A0102 studying IT B.Tech./ MBA in the  
department of CIVIL

has attended the add-on/certificate course on

ANSYS SOFTWARE

from 15/2/2021 to

28/2/2021 during the academic year 2020-2021. He/ She is advised to

maintain the same spirit in his/her future endeavors.

  
Coordinator

  
HOD

  
Principal  
GIET ENGINEERING COLLEGE,  
NH-16, Chaitanya Knowledge City,  
RAJAHMUNDRY-533 296.

  
Principal



# GIET ENGINEERING COLLEGE

Approved by AICTE, New Delhi/Affiliated to JNTUK, Kakinada/Accredited by NAAC  
NH-16, Chaitanya Knowledge City, GIET Campus, Rajamahendravaram-533296, AP, India.  
Phone: 96529 29111, Website: [www.gietec.ac.in](http://www.gietec.ac.in), Email: [principalgec@giet.ac.in](mailto:principalgec@giet.ac.in)

## CERTIFICATE

Certified that Mr./Ms. JEELAKARRA VEERENDRA

bearing the PIN 18T95A0111 studying B.Tech./ MBA in the  
department of CIVIL

has attended the add-on/certificate course on

ANSYS SOFTWARE



from 15/2/2021 to

28/02/2021 during the academic year 2020-2021. He/ She is advised to

maintain the same spirit in his/her future endeavors.

  
Coordinator

  
HOD

  
Principal  
GIET ENGINEERING COLLEGE  
NH-16, Chaitanya Knowledge City,  
RAJAHMUNDY-533 296.  
  
Principal



# GIET ENGINEERING COLLEGE

Approved by AICTE, New Delhi/Affiliated to JNTUK, Kakinada/Accredited by NAAC  
NH-16, Chaitanya Knowledge City, GIET Campus, Rajamahendravaram-533296, AP, India.  
Phone: 96529 29111, Website: [www.gietec.ac.in](http://www.gietec.ac.in), Email: [principalgec@giet.ac.in](mailto:principalgec@giet.ac.in)

## CERTIFICATE

Certified that Mr./Ms. NUNNA RAJKUMAR

bearing the PIN 18795A0118 studying IV B.Tech./ MBA in the  
department of CIVIL

has attended the add-on/certificate course on

ANSYS SOFTWARE

from 15/2/2021 to

28/2/2021 during the academic year 2020-2021

. He/ She is advised to

maintain the same spirit in his/her future endeavors.

  
Coordinator

  
HOD

  
Principal  
GIET ENGINEERING COLLEGE,  
NH-16, Chaitanya Knowledge City,  
RAJAHMUNDRY-533 296.

  
Principal



# GIET ENGINEERING COLLEGE

Approved by AICTE, New Delhi/Affiliated to JNTUK, Kakinada/Accredited by NAAC  
NH-16, Chaitanya Knowledge City, GIET Campus, Rajamahendravaram-533296, AP, India.  
Phone: 96529 29111, Website: [www.gietec.ac.in](http://www.gietec.ac.in), Email: [principalgec@giet.ac.in](mailto:principalgec@giet.ac.in)

## CERTIFICATE

Certified that Mr./Ms. SHEIK NOOR MOHAMMAD

bearing the PIN 18795A0124 studying TV B.Tech./ MBA in the

department of CIVIL has attended the add-on/certificate course on

ANCYS SOFTWARE

from 15/2/2021 to

28/2/2021 during the academic year 2020-2021. He/ She is advised to

maintain the same spirit in his/her future endeavors.

  
Coordinator

  
HOD

  
Principal  
GIET ENGINEERING COLLEGE,  
NH-16, Chaitanya Knowledge City,   
RAJAHMUNDRY-533 296.

## Organising Committee

### Chief Patron

Shri. KVV Satyanarayana Raju  
Chairman, Chaitanya Group

### Patrons

Shri. K. Sasi Kiran Varma  
Vice-chairman, Chaitanya Group  
Smt. K. V. V. Lakshmi  
Executive Director, Chaitanya Group

### Co-Patrons

Dr. D. L. N. Raju  
CEO, Chaitanya Group  
P. Subba Raju  
General Manager, GIET Institutions

### Chairperson

Dr.S. Suryanarayana Raju  
Principal, GIET Engineering College

### Convener

Dr. P.Subbarao,  
Head of the department,  
Department of Management Studies,  
Email: [mba.gec@giet.ac.in](mailto:mba.gec@giet.ac.in)

### Co-ordinator

Mr. R.Sai Pandu,,  
Assistant Professor,  
Department of Management Studies  
Mobile No: 9490887592  
Email id: [rsaipandu@giet.ac.in](mailto:rsaipandu@giet.ac.in)

## A Certificate Program on

## "Strategic Leadership"

### REGISTRATION FORM

1. Name of the Participant:
2. Class:
3. Roll Number:
4. Academic Year:
5. Branch:
6. Phone Number:
7. Email ID:
8. Address for Communication:
9. Signature of Participant:
10. Signature of class teacher:
11. Remarks (if any)

Date:

Station:

HOD

Principal  
GIET ENGINEERING COLLEGE,  
NH-16, Chaitanya Knowledge City,  
RAJAHMUNDRY-533 296.



## A Certificate Program on

## "Strategic Leadership"

15-02-2021 to 28-02-2021



Organized  
by

DEPARTMENT OF  
MANAGEMENT STUDIES

**GIET ENGINEERING COLLEGE**

(Formerly Known as Chaitanya Institute of Engineering & Technology)  
Approved by AICTE | Affiliated to JNTUK, Kakinada | Accredited by NAAC

NH-16, Chaitanya Knowledge City, GIET  
Campus, Rajamahendravaram, AP.



## About the Institute

The college is located at Chaitanya Nagar on NH-16 on the outskirts of Rajamahendravaram, in GIET campus. GIET Engineering College is an epitome of excellence in every aspect. Institute is Approved by AICTE and affiliated to JNTUK, Kakinada, Andhra Pradesh.

The Institute got accredited by NAAC. The institute offers undergraduate programs in diverse engineering streams. It features state-of-the-art facilities and a highly qualified and knowledgeable pool of staff members, apart from the prescribed course curriculum, the institute offers an entire educational experience with greater exposure of students advanced skill learning via existing centres of excellence. It has been a pioneer in adopting several pedagogic innovations for the benefit of students. The achievements of the students of this institution in academics as well as placements stand testimony to the fact.



## About the Department

The primary objectives of the management department are to examine the data, refute the logic, challenge the conventional wisdom, and rethink business and management, which are prerequisites for business leaders and managers.

The department uses a variety of teaching methods including the case study approach, LPA (Learn, Practice, and Apply), activity-based learning (ABL), industrial visits, guest lectures, seminars, business fests, community activities, and more. There are scheduled interactive sessions with business professionals and entrepreneurs where insights on the theoretical underpinnings of modern entrepreneurship and innovation as well as honed business experience are shared.

The quality teaching and guidance by highly experienced faculty members provide the best quality educational experience to the students. The regular interaction between students and faculty helps a student to apply theoretical knowledge to real-life situations. Moreover, the faculty members organize special sessions for students, can help the aspirers to become a successful entrepreneur and corporate leaders of the business.

## About the Program



Strategic leadership is a practice in which executives, using different styles of management, develop a vision for their organization that enable sit to adapt to or remain competitive in a changing economic and technological climate

The main objective of the program is to Recognize themselves as leaders and Understand the practices of empowering leaders Strategic Leadership through five myths of leadership and styles of communication and barriers of effective communication. At the end of the programme the student can understand How to apply the 4 Dimensions of Leadership Development.

### Resource Person

**Dr.P.Subba Rao,**

Head of the Department of MBA

GIET Engineering college,

Mobile No: 9502952929

Email id: [mba.gec@giet.ac.in](mailto:mba.gec@giet.ac.in)



## GIET ENGINEERING COLLEGE

NH - 16, Chaitanya Knowledge City, GIET Campus, Rajamahendravaram,  
Andhra Pradesh - 533296 Website: <http://www.gietec.ac.in> Email: [principalgec@giet.ac.in](mailto:principalgec@giet.ac.in)

### LIST OF REGISTERED STUDENTS

Name of the Program: "A Certificate Program on Strategic Leadership "

Duration: 15-02-2021 to 28-02-2021 (Two weeks)

A.Y: 2020-2021

Sl. No	PIN Number	Name of the Student	Department	Signature
1	20T91E0001	BODDEDA PADMAVATHI	I MBA	B. Padmaavathi
2	20T91E0002	DONGA YAMINI	I MBA	Donga Yamini
3	20T91E0003	GOLLA PAVAN SATYA SAI	I MBA	G. P. S. Sai
4	20T91E0004	HEMANTH KUMAR NAIDU TUMMA	I MBA	Hemant Kumar
5	20T91E0005	KANCHERLA BHARATI ANASUYA	I MBA	K. B. Anasuya
6	20T91E0006	CHAPALA SURESH	I MBA	C. Suresh
7	20T91E0007	MOHAMMED IRFAN SHARIF	I MBA	M. Sharif
8	20T91E0008	PALIVELA MOHAN KUMAR	I MBA	P. M. Kumar
9	20T91E0009	PEDDAPATI KEDHARI GOWRI	I MBA	P. K. Kedhari Gowri
10	20T91E0010	SUNNAPU PAVAN DURGA KALYAN	I MBA	S. Durgakalyani
11	20T91E0011	SYED SULTANA	I MBA	Sayed Sultana
12	20T91E0012	VANAPALLI PAVAN KUMAR	I MBA	V. P. Kumar
13	20T91E0013	VANKA SOMA SEKHAR	I MBA	V. Soma Sekhar
14	20T91E0014	YEJJU SWAMY	I MBA	Y. Swamy

  
Coordinator

  
Principal  
GIET ENGINEERING COLLEGE,  
NH-16, Chaitanya Knowledge City,  
RAJAHMUNDRY - 533 296.

  
HOD



## GIET ENGINEERING COLLEGE

NH - 16, Chaitanya Knowledge City, GIET Campus, Rajamahendravaram,  
Andhra Pradesh - 533296 Website: <http://www.gietec.ac.in> Email: [principalgect@giet.ac.in](mailto:principalgect@giet.ac.in)

### Day-wise Attendance Sheet

Name of the Program: "A Certificate Program on Strategic Leadership"

Academic Year: 2020-21

Sl.No	PIN Number	Day-1	Day-2	Day-3	Day-4	Day-5	Day-6	Day-7	Day-8	Day-9	Day-10	Day-11	Day-12
1	20T91E0001	P	P	P	P	P	P	P	P	P	P	P	P
2	20T91E0002	P	P	P	P	P	P	P	P	P	P	P	P
3	20T91E0003	P	P	P	P	P	P	P	P	P	A	P	P
4	20T91E0004	P	A	P	P	P	P	P	P	P	P	P	P
5	20T91E0005	P	P	P	P	P	P	P	P	P	P	P	P
6	20T91E0006	P	P	P	P	A	P	P	P	P	P	P	P
7	20T91E0007	P	P	P	P	P	P	P	P	P	P	P	P
8	20T91E0008	P	P	P	P	P	P	P	P	P	P	P	P
9	20T91E0009	P	P	P	P	P	P	P	A	P	P	P	P
10	20T91E0010	P	P	P	P	P	P	P	P	P	P	P	P
11	20T91E0011	P	P	P	P	P	P	P	P	P	P	A	P
12	20T91E0012	P	P	P	P	P	P	P	P	P	P	P	P
13	20T91E0013	P	P	P	P	P	P	P	P	P	P	P	P
14	20T91E0014	P	P	P	P	P	P	P	P	P	P	P	P

Present: P, Absent: A

  
**Coordinator**

  
**Principal**  
GIET ENGINEERING COLLEGE,  
NH-16, Chaitanya Knowledge City,  
RAJAHMUNDRY - 533 296.

  
**HOD**



# GIET ENGINEERING COLLEGE

NH - 16, Chaitanya Knowledge City, GIET Campus, Rajamahendravaram,  
Andhra Pradesh - 533296 Website: <http://www.gietec.ac.in> Email: [principalgec@giet.ac.in](mailto:principalgec@giet.ac.in)

---

Date: 02-03-2021

## PROGRAM REPORT

**Name of the Program** : "A Certificate Program on Strategic Leadership"  
**Date/Duration** : 15-02-2021 to 28-02-2021 (Two Week).  
**Resource Person** : Dr.P.Subba Rao,  
Head of the Department of MBA  
GIET Engineering college,  
Phone:9502952929  
Mail:mba.gec@giet.ac.in  
**Name of the Coordinator:** Mr. R.Sai Pandu, Assistant Professor, MBA  
**No of the Participants** 14

### Program Objectives

- Recognize themselves as leaders
- Understand the practices of empowering leaders Strategic Leadership training course
- Understand the fundamentals of teams and team leadership
- Establish clear performance expectations
- Improve personal productivity and self-leadership
- Solve complex problems, lead organizational change and engage with stakeholders at all levels
- Learn how to assess your current level of performance to reveal game-changing dimensions that can create significant competitive advantage
- Provide a new set of developmental tools to prepare you for leadership in a volatile, uncertain, complex and ambiguous (VUCA) business environment
- Setting up the Coachee and Coach for Success Every Time

### Topics Covered

- The five myths of leadership
- styles of communication and barriers of effective communication
- Fundamentals of effective teams vs traditional work groups
- Team decision-making and problem-solving
- The Emotional Intelligence and leadership connection
- How to apply the 4 Dimensions of Leadership Development
- Understand what makes your boss tick (and what ticks them off) to get their buy-in
- How to use available resources more effectively to achieve desired results
- How to mobilize colleagues, clients and suppliers etc.

  
Principal  
GIET ENGINEERING COLLEGE,  
NH-16, Chaitanya Knowledge City,  
RAJAHMUNDRY-533 296.



# GIET ENGINEERING COLLEGE

Approved by AICTE, New Delhi/Affiliated to JNTUK, Kakinada/Accredited by NAAC  
NH-16, Chaitanya Knowledge City, GIET Campus, Rajamahendravaram-533296, AP, India.  
Phone: 96529 29111, Website: [www.gietec.ac.in](http://www.gietec.ac.in), Email: [principalgec@giet.ac.in](mailto:principalgec@giet.ac.in)

## CERTIFICATE

Certified that Mr./Ms. Boddeda padmavathi

bearing the PIN 20T91E0001 studying I year B.Tech./ MBA in the

department of Management studies has attended the add-on/certificate course on

"Strategic Leadership" from 15/02/2021 to

28/02/2021 during the academic year 2020 - 2021. He/ She is advised to

maintain the same spirit in his/her future endeavors.

  
Coordinator

  
HOD

  
Principal  
GIET ENGINEERING COLLEGE,  
NH-16, Chaitanya Knowledge City,  
RAJAHMUNDRY-533 296.



# GIET ENGINEERING COLLEGE

Approved by AICTE, New Delhi/Affiliated to JNTUK, Kakinada/Accredited by NAAC  
NH-16, Chaitanya Knowledge City, GIET Campus, Rajamahendravaram-533296, AP, India.  
Phone: 96529 29111, Website: [www.gietec.ac.in](http://www.gietec.ac.in), Email: [principalgec@giet.ac.in](mailto:principalgec@giet.ac.in)

## CERTIFICATE

Certified that Mr./Ms. Palivela mohan kumar

bearing the PIN 20791E0008 studying I year B.Tech./ MBA in the

department of Management studies has attended the add-on/certificate course on

"strategic Leadership" from 15/02/2021 to

28/02/2021 during the academic year 2020 - 2021. He/She is advised to

maintain the same spirit in his/her future endeavors.

  
Coordinator

  
HOD

  
Principal  
GIET ENGINEERING COLLEGE,  
NH-16, Chaitanya Knowledge City,  
RAJAHMUNDRY-533 296.

  
Principal



# GIET ENGINEERING COLLEGE

Approved by AICTE, New Delhi/Affiliated to JNTUK, Kakinada/Accredited by NAAC  
NH-16, Chaitanya Knowledge City, GIET Campus, Rajamahendravaram-533296, AP, India.  
Phone: 96529 29111, Website: [www.gietec.ac.in](http://www.gietec.ac.in), Email: [principalgec@giet.ac.in](mailto:principalgec@giet.ac.in)

## CERTIFICATE

Certified that Mr./Ms. Vanka Soma sekhar

bearing the PIN 20791E0013 studying I-year B.Tech./ MBA in the

department of management studies has attended the add-on/certificate course on

"Strategic Leadership" from 15/02/2021 to

28/2/2021 during the academic year 2020 - 2021. He/ She is advised to

maintain the same spirit in his/her future endeavors.

  
Coordinator

  
HOD

  
Principal  
GIET ENGINEERING COLLEGE,  
NH-16, Chaitanya Knowledge City,  
RAJAHMUNDRY-533 296.

  
Principal



# GIET ENGINEERING COLLEGE

Approved by AICTE, New Delhi/Affiliated to JNTUK, Kakinada/Accredited by NAAC  
NH-16, Chaitanya Knowledge City, GIET Campus, Rajamahendravaram-533296, AP, India.  
Phone: 96529 29111, Website: [www.gietec.ac.in](http://www.gietec.ac.in), Email: [principalgec@giet.ac.in](mailto:principalgec@giet.ac.in)

## CERTIFICATE

Certified that Mr./Ms. Paddapati kedhasi Gowdi

bearing the PIN 20791E0009 studying I - year B.Tech./ MBA in the

department of Management Studies has attended the add-on/certificate course on

"strategic Leadership" from 15/02/2021 to

28/02/2021 during the academic year 2020-2021. He/ She is advised to

maintain the same spirit in his/her future endeavors.

  
Coordinator

  
HOD

  
Principal  
GIET ENGINEERING COLLEGE,  
Nri-16, Chaitanya Knowledge City,  
RAJAHMUNDRY-533 296.

  
Principal





# GIET ENGINEERING COLLEGE

Approved by AICTE, New Delhi/Affiliated to JNTUK, Kakinada/Accredited by NAAC  
NH-16, Chaitanya Knowledge City, GIET Campus, Rajamahendravaram-533296, AP, India.  
Phone: 96529 29111, Website: [www.gietec.ac.in](http://www.gietec.ac.in), Email: [principalgec@giet.ac.in](mailto:principalgec@giet.ac.in)

## CERTIFICATE

Certified that Mr./Ms. Yeju Swamy

bearing the PIN 20791E0014 studying I year B.Tech./ MBA in the

department of Management Studies has attended the add-on/certificate course on

"Strategic Leadership" from 15/02/2021 to

28/02/2021 during the academic year 2020 - 2021. He/She is advised to

maintain the same spirit in his/her future endeavors.

  
Coordinator

  
HOD

  
Principal  
GIET ENGINEERING COLLEGE, Principal  
NH-16, Chaitanya Knowledge City,  
RAJAHMUNDRY-533 296.

**Organising Committee**

**Chief Patron**

Shri. KVV Satyanarayana Raju  
Chairman, Chaitanya Group

**Patrons**

Shri. K. Sasi Kiran Varma  
Vice-chairman, Chaitanya Group  
Smt. K. V. V. Lakshmi  
Executive Director, Chaitanya Group

**Co-Patrons**

Dr. D. L. N. Raju  
CEO, Chaitanya Group  
P. Subba Raju  
General Manager, GIET Institutions

**Chairperson**

Dr.T.Vamsee Kiran  
Principal, GIET Engineering College

**Convener**

Mr.A.V.Sridhar,  
Associate Professor,  
Department of Mechanical Engineering  
Mobile No: 9908942849  
Email iddrsridharav@gmail.com

**Co-ordinator**

Mr.K.Sai Sasidhar  
Assistant Professor,  
Department of Mechanical Engineering  
Email:sasidhar224@gmail.com

**A Two Week Add on Program on  
“Hands on Training in NDT”**

**REGISTRATION FORM**

1. Name of the Participant:
2. Class:
3. Roll Number:
4. Academic Year:
5. Branch:
6. Phone Number:
7. Email ID:
8. Address for Communication:
9. Signature of Participant:
10. Signature of class teacher:
11. Remarks (if any)

Date:

Station:

  
Principal  
GIET ENGINEERING COLLEGE HOD  
NH-16, Chaitanya Knowledge City,  
RAJAHMUNDRY-533 296.



**A Two Week Add on Program on  
“Hands on Training in NDT”  
15.02.2021 to 28.02.2021**



**Organized  
by**

**DEPARTMENT OF  
MECHANICAL ENGINEERING**

**GIET ENGINEERING COLLEGE**

(Formerly Known as Chaitanya Institute of Engineering & Technology)  
Approved by AICTE | Affiliated to JNTUK, Kakinada | Accredited by NAAC

NH-16, Chaitanya Knowledge City, GIET  
Campus, Rajamahendravaram, AP.

### About the Institute

The college is located at Chaitanya Nagar on NH-16 on the outskirts of Rajamahendravaram, in GIET campus. GIET Engineering College is an epitome of excellence in every aspect. Institute is Approved by AICTE and affiliated to JNTUK, Kakinada, Andhra Pradesh.

The Institute got accredited by NAAC. The institute offers undergraduate programs in diverse engineering streams. It features state-of-the-art facilities and a highly qualified and knowledgeable pool of staff members. Apart from the prescribed course curriculum, the institute offers an entire educational experience with greater exposure of students advanced skill learning via existing centres of excellence. It has been a pioneer in adopting several pedagogic innovations for the benefit of students. The achievements of the students of this institution in academics as well as placements stand testimony to the fact.



### About the Department

Mechanical engineering is an evergreen discipline that involved in the application of basic science and mathematical principles to design, analyze, manufacture, and maintenance of mechanical systems. Mechanical engineers work across a huge variety of industries. Mechanical engineers are in the design, manufacture and maintenance of things ranging from a small safety pin to a giant ship. It is one of the oldest branches of engineering, it is also one that continues to change and grow with the advancements in technology making it a vibrant and exciting career path even to this day. The total number of engineers employed in the U.S. in 2015 was roughly 1.6 million. Of these 17.28% were mechanical engineers, the largest discipline by size.

The department is equipped with academically sound and experienced faculty specialized in various areas of mechanical engineering. The department is provided with state of the art laboratories and software. In addition to the regular curriculum we conduct programs like add-on training programs on drafting, solid modelling, etc., Industrial visits, Seminars, Hands-on workshops on latest technologies to enhance the skills of the students to meet the demands of the industry.

### About the Program



Nondestructive testing (NDT) blends quality assurance and materials science into a profession devoted to inspecting, testing, and evaluating materials, components, or assemblies. Using a set of test methods, technicians identify cracks, voids, inclusions, and weld discontinuities, as well as identify misassembled subcomponents, without destroying the serviceability of the part or system.

NDT is used to ensure product integrity and reliability, control manufacturing processes, lower production costs, and maintain a uniform quality level.

### Resource Person

**Mr.P.Vipin Raj**

Assistant Professor

GIET Engineering College,

Rajahmundry.

Mobile No:8885666088

Email id: vipinraj777@gmail.com



# GIET ENGINEERING COLLEGE

NH - 16, Chaitanya Knowledge City, GIET Campus, Rajamahendravaram,  
Andhra Pradesh - 533296 Website: <http://www.gietec.ac.in> Email: [principalgec@giet.ac.in](mailto:principalgec@giet.ac.in)

## List of students enrolled for A Two Week Certificate Program on Web Technologies and its Applications

S.NO	PIN NO	NAME OF THE STUDENT	PROGRAM NAME	YEAR-SEMETER	SIGNATURE OF STUDENT
1	19T91A0302	AKULA AMARANATH	B.TECH-MECH	II-II	A. Amara Nath
2	19T91A0303	BOMMULA DORAJI SRINIVASA RAO	B.TECH-MECH	II-II	B.D. Srinivasa Rao
3	19T91A0304	SHAIK BADEY SAHEB	B.TECH-MECH	II-II	S.B. Saheb
4	19T91A0305	KOTHAPALLI JAYA RAMA VINAY KUMAR	B.TECH-MECH	II-II	K.J.R.V. Kumar
5	19T91A0306	KARRI SIVASAGAR	B.TECH-MECH	II-II	K. Sivasagar
6	19T91A0307	VINNAKOTA GANESH	B.TECH-MECH	II-II	V. Ganesh
7	20T95A0301	GANGAVARAPU DEVI PRASAD	B.TECH-MECH	II-II	G. Devi Prasad
8	20T95A0302	SALAVURAO JAYA PRAKASH	B.TECH-MECH	II-II	S. Jaya Prakash
9	20T95A0303	GORLE PRASAD	B.TECH-MECH	II-II	G. Prasad
10	20T95A0304	INAKOTI ARUN VENKATA KUMAR	B.TECH-MECH	II-II	I. Arun Venkata Kumar

  
COORDINATOR

  
Principal  
GIET ENGINEERING COLLEGE,  
NH-16, Chaitanya Knowledge City,  
RAJAHMUNDRY - 533 296.

  
HOD



Approved by NAAC

### GIET ENGINEERING COLLEGE

NH-16, Chaitanya Knowledge City, GIET Campus, Rajamahendravaram, Andhra Pradesh-533296 Website: <http://www.gietec.ac.in> Email: [principal@giet.ac.in](mailto:principal@giet.ac.in)

#### DEPARTMENT OF MECHANICAL ENGINEERING

#### Day wise attendance

S.NO	PIN NO	NAME OF THE STUDENT	15-02-2021	16-02-2021	17-02-2021	18-02-2021	19-02-2021	20-02-2021	22-02-2021	23-02-2021	24-02-2021	25-02-2021	26-02-2021	27-02-2021
1	19T91A0302	AKULA AMARANATH	A	P	P	P	P	P	P	P	P	P	P	P
2	19T91A0303	BOMMULA DORAJI SRINIVASA RAO	P	P	P	P	P	P	A	P	P	P	P	P
3	19T91A0304	SHAIK BADEY SAHEB	P	P	A	P	P	P	P	P	P	P	P	P
4	19T91A0305	KOTHAPALLI JAYA RAMA VINAY KUMAR	P	P	P	P	P	P	P	P	P	P	P	P
5	19T91A0306	KARRI SIVASAGAR	P	P	P	P	P	P	P	P	P	P	P	P
6	19T91A0307	VINNAKOTA GANESH	P	P	P	P	P	P	A	P	P	P	P	P
7	20T95A0301	GANGAVARAPU DEVI PRASAD	P	P	P	P	P	P	P	P	P	P	P	A
8	20T95A0302	SALAVURAO JAYA PRAKASH	P	P	A	P	P	A	P	P	P	A	P	P
9	20T95A0303	GORLE PRASAD	A	P	P	P	P	P	P	P	P	P	P	P
10	20T95A0304	INAKOTI ARUN VENKATA KUMAR	P	P	P	P	A	P	P	P	P	P	P	P

COORDINATOR

Principal

GIET ENGINEERING COLLEGE,  
NH-16, Chaitanya Knowledge City,  
RAJAHMUNDRY - 533 296.

HOD

2020-2021 2<sup>nd</sup> year



## GIET ENGINEERING COLLEGE

NH - 16, Chaitanya Knowledge City, GIET Campus, Rajamahendravaram,  
Andhra Pradesh - 533296 Website: <http://www.gietec.ac.in> Email: [principalgec@giet.ac.in](mailto:principalgec@giet.ac.in)

Date:01.03.2021

### PROGRAM REPORT

**Name of the Program** : "A Two-Week Certificate Program on Hands-on Training in NDT (NONDESTRUCTIVE TESTING) methods and techniques"

**Date/Duration** : 15.02.2021 to 28.02.2021(Two weeks)

**Resource Person** : Mr.P.VIPIN RAJ

Assistant professor

MECH GIET ENGINEERING COLLEGE

Rajahmundry, A.P

Phone:88885666088

Mail:[vipinraj7777@gmail.com](mailto:vipinraj7777@gmail.com)

**Name of the Coordinator** : Mr.K.Sai Sasidhar Assistant Professor ,MECH

**No of the Participants** : 10

**Program Objective** :

- NDT is testing and analysis technique used by industry
- NDT is to inspect a component in a safe
- NDT is to inspect a component in a reliable

**Topics Covered** :The following topics are covered

- Visual testing
- Ultra sonic testing
- Radiography testing
- Eddy current testing
- Leak testing

  
Principal  
GIET ENGINEERING COLLEGE,  
NH-16, Chaitanya Knowledge City,  
RAJAHMUNDRY-533 296.



## GIET ENGINEERING COLLEGE

NH - 16, Chaitanya Knowledge City, GIET Campus, Rajamahendravaram,  
Andhra Pradesh - 533296 Website: <http://www.gietec.ac.in> Email: [principalgec@giet.ac.in](mailto:principalgec@giet.ac.in)

---

**Program Outcome :**

- The students shall be able to find the internal flaws in material
- NDT and take measures to eliminate them
- The students shall be solve various problems
- Cracks, blowholes with manufacturing processes by analyzing data.

  
**Coordinator**

  
Principal  
GIET ENGINEERING COLLEGE,  
NH-16, Chaitanya Knowledge City,  
RAJAHMUNDRY - 533 296.

  
**HOD**



# GIET ENGINEERING COLLEGE

Approved by AICTE, New Delhi/Affiliated to JNTUK, Kakinada/Accredited by NAAC  
NH-16, Chaitanya Knowledge City, GIET Campus, Rajamahendravaram-533296, AP, India.  
Phone: 96529 29111, Website: [www.gietec.ac.in](http://www.gietec.ac.in), Email: [principalgec@giet.ac.in](mailto:principalgec@giet.ac.in)

## CERTIFICATE

Certified that Mr./Ms. AKULA AMARNATH

bearing the PIN 19T9/A0302 studying IV B.Tech./MBA in the

department of MECHANICAL ENG has attended the add-on/certificate course on



HANDS ON TRAINING IN NDT from 15-02-2021 to

28-02-2021 during the academic year 2020-21. He/She is advised to

maintain the same spirit in his/her future endeavors.

  
Coordinator

  
HOD

  
Principal  
GIET ENGINEERING COLLEGE,  
Nr.-15, Chaitanya Knowledge City,  
RAJAHMUNDRY-533 296.  Principal





# GIET ENGINEERING COLLEGE

Approved by AICTE, New Delhi/Affiliated to JNTUK, Kakinada/Accredited by NAAC  
NH-16, Chaitanya Knowledge City, GIET Campus, Rajamahendravaram-533296, AP, India.  
Phone: 96529 29111, Website: [www.gietec.ac.in](http://www.gietec.ac.in), Email: [principalgec@giet.ac.in](mailto:principalgec@giet.ac.in)

## CERTIFICATE

Certified that Mr./Ms. BOMMULA DORAJI SRINIVASARAO

bearing the PIN 19T91A0303 studying II B.Tech./MBA in the

department of MECHANICAL ENGG has attended the add-on/certificate course on

HANDS ON TRAINING IN NDT from 15-02-2021 to

28-02-2021 during the academic year 2020-21. He/She is advised to

maintain the same spirit in his/her future endeavors.

  
Coordinator

  
HOD

  
Principal  
GIET ENGINEERING COLLEGE,  
NH-16, Chaitanya Knowledge City,  
RAJAHMUNDRY-533-296.

  
Principal



# GIET ENGINEERING COLLEGE

Approved by AICTE, New Delhi/Affiliated to JNTUK, Kakinada/Accredited by NAAC  
NH-16, Chaitanya Knowledge City, GIET Campus, Rajamahendravaram-533296, AP, India.  
Phone: 96529 29111, Website: [www.gietec.ac.in](http://www.gietec.ac.in), Email: [principalgec@giet.ac.in](mailto:principalgec@giet.ac.in)

## CERTIFICATE

Certified that Mr./Ms. GIORLE PRASAD

bearing the PIN 20T95A0303 studying II B.Tech./MBA in the

department of MECHANICAL ENGG has attended the add-on/certificate course on

HANDS ON TRAINING IN NDT from 15-02-2021 to

28-02-2021 during the academic year 2020-21. He/She is advised to

maintain the same spirit in his/her future endeavors.

  
Coordinator

  
HOD

  
Principal  
GIET ENGINEERING COLLEGE,  
NH-16, Chaitanya Knowledge City,  
RAJAHMUNDRY-533 296.

  
Principal



# GIET ENGINEERING COLLEGE

Approved by AICTE, New Delhi/Affiliated to JNTUK, Kakinada/Accredited by NAAC  
NH-16, Chaitanya Knowledge City, GIET Campus, Rajamahendravaram-533296, AP, India.  
Phone: 96529 29111, Website: [www.gietec.ac.in](http://www.gietec.ac.in), Email: [principalgec@giet.ac.in](mailto:principalgec@giet.ac.in)

## CERTIFICATE

Certified that Mr./Ms. SHAIK BADEY SAHEB

bearing the PIN 19T91A0304 studying II B.Tech./MBA in the

department of MECHANICAL ENGG has attended the add-on/certificate course on

HANDS ON TRAINING IN NDT from 15-02-2021 to

28-02-2021 during the academic year 2020-2021. He/She is advised to

maintain the same spirit in his/her future endeavors.

  
Coordinator

  
HOD

  
Principal  
GIET ENGINEERING COLLEGE  
NH-16, Chaitanya Knowledge City,  
RAJAHMUNDRY-533 296.

  
Principal



# GIET ENGINEERING COLLEGE

Approved by AICTE, New Delhi/Affiliated to JNTUK, Kakinada/Accredited by NAAC  
NH-16, Chaitanya Knowledge City, GIET Campus, Rajamahendravaram-533296, AP, India.  
Phone: 96529 29111, Website: [www.gietec.ac.in](http://www.gietec.ac.in), Email: [principalgec@giet.ac.in](mailto:principalgec@giet.ac.in)

## CERTIFICATE

Certified that Mr./Ms. T NAKOTI ARUN VENKATA KUMAR

bearing the PIN 20795A0304 studying II B.Tech./MBA in the

department of MECHANICAL ENG has attended the add-on/certificate course on

HANDS ON TRAINING IN NDT from 15-02-2021 to

28-02-2021 during the academic year 2020-21. He/She is advised to

maintain the same spirit in his/her future endeavors.

  
Coordinator

  
HOD

  
Principal  
GIET ENGINEERING COLLEGE,  
NH-16, Chaitanya Knowledge City,  
RAJAHMUNDRY-533 296.

  
Principal



## About the Institute

The college is located at Chaitanya Nagar on NH-16 on the outskirts of Rajamahendravaram, in GIET campus. GIET Engineering College is an epitome of excellence in every aspect. Institute is Approved by AICTE and affiliated to JNTUK, Kakinada, Andhra Pradesh.

The Institute got accredited by NAAC. The institute offers undergraduate programs in diverse engineering streams. It features state-of-the-art facilities and a highly qualified and knowledgeable pool of staff members. apart from the prescribed course curriculum, the institute offers an entire educational experience with greater exposure of students advanced skill learning via existing centres of excellence. It has been a pioneer in adopting several pedagogic innovations for the benefit of students. The achievements of the students of this institution in academics as well as placements stand testimony to the fact.



## About the Department

The department of Electrical and Electronics Engineering was established in the year 2009 with an initial intake of 60 students. The UG program of the department of Electrical and Electronics Engineering imparts solid technical background and research capabilities among the students which help them to excel in their respective fields.

It has an array of courses for students to choose from and study such as Electrical and Electronics Engineering ,Electronic devices, Power Systems, Electrical Machines, Control Systems Microcontroller, electrical circuit analysis, Power systems operations and controlling, Digital Electronics, Digital Signal Processing, Digital Control Systems, Electro Static Field, Utilization Of Electrical Energy.. and More.

The quality teaching and guidance by highly experienced faculty members provide the best quality educational experience to the students. The regular interaction between students and faculty helps a student to apply theoretical knowledge to real-life situations. Moreover, the faculty members organize special sessions for topics such as electronics, control system, networking, etc. that assures their placement in renowned multinational companies.

## About the Program

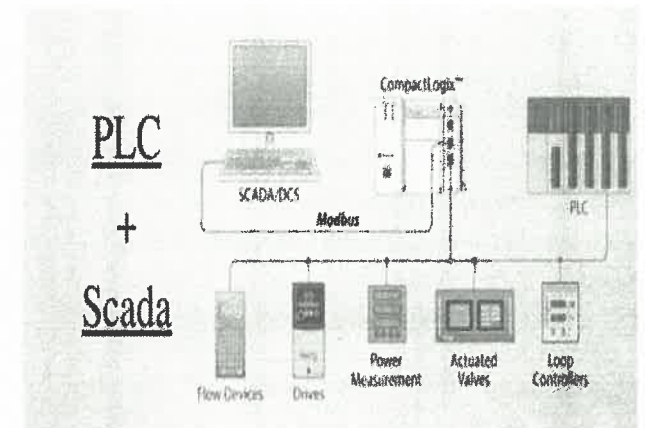

### Objectives of the Program:

- To understand the generic architecture and constituent components of a Programmable Logic Controller.
- To develop a software program using modern engineering tools and technique for PLC and SCADA.
- To apply knowledge gained about PLCs and SCADA systems to real-life industrial applications.

### Resource Person

**Mr. G.Satyanarayana**

Professor ,EEE Dept.

GIET College of Engineering

Email.id: [gsnarayana607@gmail.com](mailto:gsnarayana607@gmail.com)

Contact number:9666444974



# GIET ENGINEERING COLLEGE

NH-16, Chaitanya Knowledge City, GIET Campus, Rajamahendravaram,  
Andhra Pradesh-533296 Website: <http://www.gietee.ac.in> Email: [principalgee@giet.ac.in](mailto:principalgee@giet.ac.in)

## LIST OF STUDENTS ENROLLED FOR A TWO WEEK CERTIFICATE PROGRAM ON PLC-SCADA

S.NO	PIN NO	NAME OF THE STUDENT	PROGRAM NAME	YEAR-SEMETER	SIGNATURE OF STUDENT
1	18MUSA0201	ALACHANDRA RAJESH	B.Tech-EEE	IV-II	A. Rajesh
2	17T91A0201	DAMMALA JAGANMOHAN	B.Tech-EEE	IV-II	Jagan
3	17T91A0202	GONNURU SRIDHAR	B.Tech-EEE	IV-II	Sridhar
4	17T91A0203	MUPPIDI CHAITANYA SUDHEER	B.Tech-EEE	IV-II	Sudheer
5	17T91A0204	GUDLA VENKATA RAMA RAO	B.Tech-EEE	IV-II	G.V. Ramarao
6	17T91A0205	NULI AVINASH	B.Tech-EEE	IV-II	N. Avinash
7	18T95A0201	DADI DURGA VARA PRASAD	B.Tech-EEE	IV-II	D.V. Prasad
8	18T95A0202	DEVARASETTI SRIVEERAVENKATANAGAMANIKANTA	B.Tech-EEE	IV-II	J.V. Manikanta
9	18T95A0205	KASIREDDY SATISH CHANDRA	B.Tech-EEE	IV-II	K. S. Chandra
10	18T95A0206	KOLISETTI NEELADEVI	B.Tech-EEE	IV-II	K. Neeladevi
11	18T95A0207	KONALA VIMALA	B.Tech-EEE	IV-II	K. Vimala
12	18T95A0209	MADDALA ANANDA RAO	B.Tech-EEE	IV-II	M. Anand
13	18T95A0210	MARRI VARAPRASAD	B.Tech-EEE	IV-II	M. V. Varaprasad
14	18T95A0211	MEESALA VEERA LOKESH	B.Tech-EEE	IV-II	M. V. Lokesh
15	18T95A0212	PALLI VINAY KUMAR	B.Tech-EEE	IV-II	P. Vinay
16	18T95A0213	POLIPALLI DEVI	B.Tech-EEE	IV-II	P. Devi
17	18T95A0214	PUPPALA RAJABABU	B.Tech-EEE	IV-II	P. Rajababu
18	18T95A0215	RAJANI SRI RAJASEKHAR REDDY	B.Tech-EEE	IV-II	R. S. Reddy
19	18T95A0216	SATYAM KRISHNA CHAITANYA	B.Tech-EEE	IV-II	S. K. Chaitanya
20	18T95A0217	THIRUPATHI MADAN BABU	B.Tech-EEE	IV-II	M. Babu
21	18T95A0219	VEGESNA SIVA RAMA KRISHNA VARMA	B.Tech-EEE	IV-II	V. Varma

Principal  
GIET ENGINEERING COLLEGE  
NH-16, Chaitanya Knowledge City,  
RAJAHMUNDRY-533 296.

Principal

GIET ENGINEERING COLLEGE,  
NH-16, Chaitanya Knowledge City,  
RAJAHMUNDRY - 533 296.

*[Handwritten Signature]*

*[Handwritten Signature]*



# GIET ENGINEERING COLLEGE

NH-16, Chaitanya Knowledge City, GIET Campus, Rajamahendravaram,  
Andhra Pradesh-533296 Website: <http://www.gietec.ac.in> Email: [principalgec@giet.ac.in](mailto:principalgec@giet.ac.in)

## DEPARTMENT OF ELECTRICAL AND ELECTRONICS ENGINEERING

### Day wise attendence

S.NO	PIN NO	NAME OF THE STUDENT	15.02.21	16.02.21	17.02.21	18.02.21	19.02.21	20.02.21	22.02.21	23.02.21	24.02.21	25.02.21	26.02.21	27.02.21
1	18MU5A0201	ALACHANDRA RAJESH	P	P	A	P	P	P	P	A	P	A	P	A
2	17T91A0201	DAMMALA JAGANMOHAN	P	P	P	P	P	P	A	P	A	P	P	P
3	17T91A0202	GONNURU SRIDHAR	P	A	P	P	P	P	P	P	P	P	P	P
4	17T91A0203	MUPPIDI CHAITANYA SUDHEER	P	P	P	P	P	P	P	P	P	P	P	P
5	17T91A0204	GUDLA VENKATA RAMA RAO	P	P	P	P	P	P	P	P	P	P	P	P
6	17T91A0205	NULI AVINASH	A	P	P	P	P	P	P	P	P	P	P	P
7	18T95A0201	DADI DURGA VARA PRASAD	A	P	P	P	P	P	P	P	A	P	P	P
8	18T95A0202	DEVARASETTI SIVIVEERAVENKATANACAMANIKANTA	P	P	P	P	P	P	P	P	P	P	P	P
9	18T95A0205	KASIREDDY SATISH CHANDRA	P	P	P	A	P	P	P	P	P	P	P	A
10	18T95A0206	KOLISETTI NEELADEVI	A	P	P	P	A	P	P	P	P	A	P	P
11	18T95A0207	KONALA VIMALA	P	P	P	P	P	P	P	P	P	P	P	P
12	18T95A0209	MADDALA ANANDA RAO	P	P	A	P	P	A	P	P	P	P	P	P
13	18T95A0210	MARRI VARAPRASAD	P	P	A	P	P	P	A	P	P	P	P	A
14	18T95A0211	MEESALA VEERA LOKESH	P	A	P	A	P	P	P	P	P	P	A	A
15	18T95A0212	PALLI VINAY KUMAR	P	P	P	P	P	P	P	P	P	A	P	P
16	18T95A0213	POLIPALLI DEVI	P	P	A	P	P	A	P	P	P	P	P	P
17	18T95A0214	PUPPALA RAJABABU	P	P	P	P	P	P	A	P	P	P	P	P
18	18T95A0215	RAJANI SRI RAJASEKHAR REDDY	P	A	P	P	A	P	P	P	P	P	P	P
19	18T95A0216	SATYAM KRISHNA CHAITANYA	P	P	P	P	A	P	P	A	P	P	A	P
20	18T95A0217	THIRUPATHI MADAN BABU	A	P	A	P	A	P	P	P	A	P	P	P
21	18T95A0219	VEGESNA SIVA RAMA KRISHNA VARMA	P	P	P	P	P	P	P	P	P	P	P	P

  
Program Coordinator

  
Principal  
GIET ENGINEERING COLLEGE,  
NH-16, Chaitanya Knowledge City,  
RAJAHMUNDRY - 533 296.

  
HOD





## **GIET ENGINEERING COLLEGE**

NH - 16, Chaitanya Knowledge City, GIET Campus, Rajamahendravaram,  
Andhra Pradesh - 533296 Website: <http://www.gietec.ac.in> Email: [principalgiet@giet.ac.in](mailto:principalgiet@giet.ac.in)

---

Date: 02.03.2021

### **PROGRAM REPORT**

**Name of the Event: A Two Week Certificate Program on PLC-SCADA**

**Date: 15.02.2021 to 28.02.2021**

**Resource Person:**

Professor , GIET Engineering college

Email.id: @giet.ac.in

Contact number:

**Name of the Coordinator: Mrs.S.V.Sailaja**

**Number of students attended: 21**

**Venue: APSSDC lab,CV RAMAN Block, GIET Engineering college**

**Objectives of the Program:**

- To understand the generic architecture and constituent components of a Programmable Logic Controller.
- To develop a software program using modern engineering tools and technique for PLC and SCADA.
- To apply knowledge gained about PLCs and SCADA systems to real-life industrial applications.

**Topics to be covered:**

- Introduction To Automation
- Why We Need Automation

Principal  
GIET ENGINEERING COLLEGE  
NH-16, Chaitanya Knowledge City,  
RAJAHMUNDRY-533 296.

- Where Automation?
- Evolution In Industrial Automation (A Brief History)
- Different Type Of Industrial Control Mechanisms)
- Introduction To PLCs
- PLC Advantages Over Microcontrollers
- Area Of Applications
- DATA Flow During Automation
- Motor Drives Introduction & Their Need
- Sensors Introduction & Their Need
- HMI Introduction & Its Need
- SCADA Introduction& Its Need

#### **Detail study of PLC & SCADA**

- PLC
- SCADA
- Allen Bradley & Rockwell Automation's Details
- Brief Description To Input/ Output Pins Of Micrologix-1000
- Ladder Diagram Basics
- Introduction To RSLogix
- Downloading A Ladder Program In PLC Using RSLinx.
- How To Take Input From Panel
- How To Give Output To Panel
- Running First PLC Application.
- Participants will perform hands on PLC training Kit.
- Programming by using Allen Bradley PLC & MicroLogix, RS Logix software.
- Troubleshooting & fault diagnostics of PLC.
- SCADA wonder ware InTouch, creating new SCADA applications, creating database of tags, creating & editing graphic display with automation.
- Connectivity with the PLC, connectivity between software and excel, troubleshooting & applications, Practical as on existing available in college.

#### **Outcomes of the Program:**

At the end of this course, the student will be able to

- Classify input and output interfacing devices with PLC.
- Execute, debug and test the programs developed for digital and analog operations.
- Determine I/O requirement of application, develop program and interface system with PLC

  
Coordinator

  
Principal  
GIET ENGINEERING COLLEGE,  
NH-16, Chaitanya Knowledge City,  
RAJAHMUNDRY-533 296.

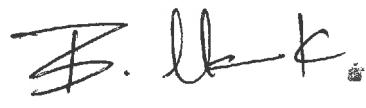
  
HOD-EEE



# GIET ENGINEERING COLLEGE

Approved by AICTE, New Delhi/Affiliated to JNTUK, Kakinada/Accredited by NAAC  
NH-16, Chaitanya Knowledge City, GIET Campus, Rajamahendravaram-533296, AP, India.  
Phone: 96529 29111, Website: [www.gietec.ac.in](http://www.gietec.ac.in), Email: [principalgec@giet.ac.in](mailto:principalgec@giet.ac.in)

## CERTIFICATE

Certified that Mr./Ms. N. Avinash  
bearing the PIN 17T91A0205 studying IV B.Tech./MBA in the  
department of EEE has attended the add-on/certificate course on  
PLC - SCADA from 15-2-21 to  
27-2-21 during the academic year 2020 - 2021. He/ She is advised to  
maintain the same spirit in his/her future endeavors.

  
Coordinator

  
HOD

  
Principal  
GIET ENGINEERING COLLEGE,  
NH-16, Chaitanya Knowledge City,  
RAJAHMUNDRY-533 296.

  
Principal



# GIET ENGINEERING COLLEGE

Approved by AICTE, New Delhi/Affiliated to JNTUK, Kakinada/Accredited by NAAC  
NH-16, Chaitanya Knowledge City, GIET Campus, Rajamahendravaram-533296, AP, India.  
Phone: 96529 29111, Website: [www.gietec.ac.in](http://www.gietec.ac.in), Email: [principalgec@giet.ac.in](mailto:principalgec@giet.ac.in)

## CERTIFICATE

Certified that Mr./Ms. RS. Rajashekar Reddy  
bearing the PIN 18T95A0215 studying IV B.Tech./MBA in the  
department of EEE has attended the add-on/certificate course on  
PLC - SCADA from 15-2-21 to  
27-2-21 during the academic year 2020 - 2021. He/She is advised to  
maintain the same spirit in his/her future endeavors.

  
Coordinator

  
HOD

  
Principal  
GIET ENGINEERING COLLEGE,  
NH-16, Chaitanya Knowledge City,  
RAJAHMUNDRY-533 296.

  
Principal



# GIET ENGINEERING COLLEGE

Approved by AICTE, New Delhi/Affiliated to JNTUK, Kakinada/Accredited by NAAC  
NH-16, Chaitanya Knowledge City, GIET Campus, Rajamahendravaram-533296, AP, India.  
Phone: 96529 29111, Website: [www.gietec.ac.in](http://www.gietec.ac.in), Email: [principalgec@giet.ac.in](mailto:principalgec@giet.ac.in)

## CERTIFICATE

Certified that Mr./Ms. M. Anand Rao

bearing the PIN 18T95A0209 studying IV B.Tech./ ~~MBA~~ in the  
department of EEE

has attended the add-on/certificate course on

PLC - SCADA

from 15-2-21 to



27-2-21 during the academic year 2020 - 2021

. He/ She is advised to

maintain the same spirit in his/her future endeavors.

  
Coordinator

  
HOD

  
Principal  
GIET ENGINEERING COLLEGE,  
NH-16, Chaitanya Knowledge City,  
RAJAHMUNDRY-533 296.   
Principal.



# GIET ENGINEERING COLLEGE

Approved by AICTE, New Delhi/Affiliated to JNTUK, Kakinada/Accredited by NAAC  
NH-16, Chaitanya Knowledge City, GIET Campus, Rajamahendravaram-533296, AP, India.  
Phone: 96529 29111, Website: [www.gietec.ac.in](http://www.gietec.ac.in), Email: [principalgec@giet.ac.in](mailto:principalgec@giet.ac.in)

## CERTIFICATE

Certified that Mr./Ms. K. Neeladevi

bearing the PIN 18T95A0206 studying IV B.Tech./MBA in the  
department of EEE

has attended the add-on/certificate course on

PLC - SCADA

from 15-2-21 to



27-2-21 during the academic year 2020 - 2021

. He/ She is advised to

maintain the same spirit in his/her future endeavors.

  
Coordinator

  
HOD

  
Principal  
GIET ENGINEERING COLLEGE,  
NH-16, Chaitanya Knowledge City,  
RAJAHMUNDRY-533 296.   
Principal



# GIET ENGINEERING COLLEGE

Approved by AICTE, New Delhi/Affiliated to JNTUK, Kakinada/Accredited by NAAC  
NH-16, Chaitanya Knowledge City, GIET Campus, Rajamahendravaram-533296, AP, India.  
Phone: 96529 29111, Website: [www.gietec.ac.in](http://www.gietec.ac.in), Email: [principalgec@giet.ac.in](mailto:principalgec@giet.ac.in)

## CERTIFICATE

Certified that Mr./Ms. G. Sidhas

bearing the PIN 17791A0202 studying IV B.Tech./MBA in the  
department of EEE

has attended the add-on/certificate course on

PLC - SCADA



from 15-2-21 to

27-2-21 during the academic year 2020 - 2021. He/ She is advised to

maintain the same spirit in his/her future endeavors.

  
Coordinator

  
HOD

  
Principal  
GIET ENGINEERING COLLEGE,  
NH-16, Chaitanya Knowledge City, Rajamahendravaram-533296, AP, India.  
Principal 

**Organising Committee**

**Chief Patron**

Shri. KVV Satyanarayana Raju  
Chairman, Chaitanya Group

**Patrons**

Shri. K. Sasi Kiran Varma  
Vice-chairman, Chaitanya Group  
Smt. K. V. V. Lakshmi  
Executive Director, Chaitanya Group

**Co-Patrons**

Dr. D. L. N. Raju  
CEO, Chaitanya Group  
P. Subba Raju  
General Manager, GIET Institutions

**Chairperson**

Dr. T. Vamsee Kiran  
Principal, GIET Engineering College

**Convener**

Mr. K. Nagaraju,  
Head of the department,  
Department of CSE  
Mobile No: 9989442311  
Email: [nagaraju@giet.ac.in](mailto:nagaraju@giet.ac.in)

**Co-ordinator**

Ms B Sai Deepthi,  
Assistant Professor,  
Department of CSE  
Mobile No: 9866440402  
Email id: [saidepthibcse@giet.ac.in](mailto:saidepthibcse@giet.ac.in)

**A Two Week Add on Program on  
“Block Chain Technology and its  
Applications”**

**REGISTRATION FORM**

1. Name of the Participant:
2. Class:
3. Roll Number:
4. Academic Year:
5. Branch:
6. Phone Number:
7. Email ID:
8. Address for Communication:
9. Signature of Participant:
10. Signature of class teacher:
11. Remarks (if any)

Date:  
Station:

*Deepthi*

Principal  
GIET ENGINEERING COLLEGE  
NH-16, Chaitanya Knowledge City,  
RAJAHMUNDRY-530 090.

HOD



**A Two Week Add on Program on  
“Block Chain Technology and its  
Applications”**

**22.02.2021 to 07.03.2021**



Organized  
by

DEPARTMENT OF  
COMPUTER SCIENCE AND ENGINEERING  
**GIET ENGINEERING COLLEGE**  
(Formerly Known as Chaitanya Institute of Engineering & Technology)  
Approved by AICTE | Affiliated to JNTUK, Hakinada | Accredited by NAAC

NH-16, Chaitanya Knowledge City, GIET  
Campus, Rajamahendravaram, AP.



## About the Institute

The college is located at Chaitanya Nagar on NH-16 on the outskirts of Rajamahendravaram, in GIET campus. GIET Engineering College is an epitome of excellence in every aspect. Institute is Approved by AICTE and affiliated to JNTUK, Kakinada, Andhra Pradesh.

The Institute got accredited by NAAC. The institute offers undergraduate programs in diverse engineering streams. It features state-of-the-art facilities and a highly qualified and knowledgeable pool of staff members. apart from the prescribed course curriculum, the institute offers an entire educational experience with greater exposure of students advanced skill learning via existing centres of excellence. It has been a pioneer in adopting several pedagogic innovations for the benefit of students. The achievements of the students of this institution in academics as well as placements stand testimony to the fact.



## About the Department

Department of COMPUTER SCIENCE AND ENGINEERING started in the year of 2005. It is offering graduate program B.Tech. Department has well qualified and dedicated faculty members.

Department has produced good number of graduates well settled in industry and some are also involved in research activities.

The Department provides state-of-the-art computing facilities to the students enabling them to stay a step ahead. The courses are designed to combine rigorous academic study and exhaustive practical exposure for students with in-depth lab-oriented courses, projects, and internships.

The Department hosts a number of workshops and student managed symposiums. The department also encourages innovative projects and Internships in various interrelated domains. The department has high-end computer labs as well as the CM Skill Excellence Centre. Because the current industry requires a student with exposure and skill set in Data Sciences, Machine Learning, Web Development, and so on, the department-driven programme is designed to prepare students for the workforce.

## About the Program

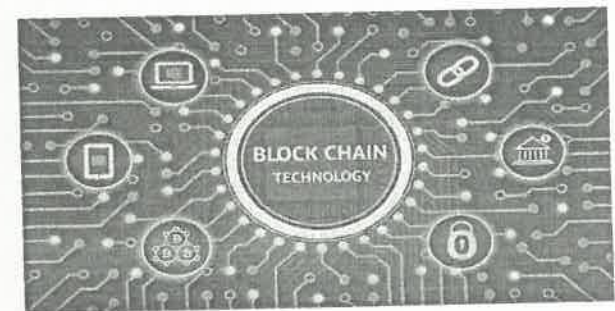

Blockchain technology is a decentralized, distributed ledger that stores the record of ownership of digital assets. Any data stored on blockchain is unable to be modified, making the technology a legitimate disruptor for industries like payments, cybersecurity and healthcare.

A blockchain database stores data in blocks that are linked together in a chain. The data is chronologically consistent because you cannot delete or modify the chain without consensus from the network.

### Resource Person

**Dr. S. K. Meera Sharif,**  
Head of the Department, CSE,  
GIET Engineering College,  
Rajahmundry.  
Mobile No:9490790137  
Email: [sharif@giet.ac.in](mailto:sharif@giet.ac.in)



Approved by NAAC

# GIET ENGINEERING COLLEGE

NH-16, Chaitanya Knowledge City, GIET Campus, Rajamahendravaram, Andhra Pradesh-533296 Website: <http://www.gietec.ac.in> Email: [principalgce@giet.ac.in](mailto:principalgce@giet.ac.in)

2020-21  
4/2/20

## List of students enrolled for A Certificate Program on Block chain technology and its Applications

S.NO	PIN NO	NAME OF THE STUDENT	PROGRAM NAME	YEAR-SEMETER	SIGNATURE OF STUDENT
1	17MU1A0553	GANNAMANI A V SRIRAM	B.Tech-CSE	IV-II	G.A.V. SRIRAM
2	16T91A0536	SANGISETTI DIVYA	B.Tech-CSE	IV-II	S. Divya
3	16T91A0552	NALLA GOVIND	B.Tech-CSE	IV-II	N. Govind
4	17T91A0501	BICCAVOLU TULASI	B.Tech-CSE	IV-II	N. Govind
5	17T91A0502	CHIKKALA JAHNAVI	B.Tech-CSE	IV-II	Ch. Jahnavi
6	17T91A0503	GEDELA THIRIMURTHULU	B.Tech-CSE	IV-II	G. Thirumurtulu
7	17T91A0504	SUNKESWARAM SRINIVASULU	B.Tech-CSE	IV-II	K. Veerababu
8	17T91A0505	KARRI VEERABABU	B.Tech-CSE	IV-II	KARRI. V. BABU
9	17T91A0506	KOLLU SATHISH	B.Tech-CSE	IV-II	K. Sathish
10	17T91A0507	KOLLU LAHARI GEETHIKA	B.Tech-CSE	IV-II	K.L. Geethika
11	17T91A0509	KUTI VEERA VENKATA CHAKRAVARTHI	B.Tech-CSE	IV-II	V. Chakrathi
12	17T91A0510	M A P VENKATA SAI PHANEENDRA	B.Tech-CSE	IV-II	V. Sai
13	17T91A0512	KADAVAKOLLU SADVIKA LAKSHMI PRIYA	B.Tech-CSE	IV-II	K.S. & L. PRIYA
14	17T91A0514	PULIGUNDLA S S SUDESHNA	B.Tech-CSE	IV-II	S. Sudeshna
15	17T91A0515	RAMANOJU AKHILA RANI	B.Tech-CSE	IV-II	R. Akhila Rani
16	17T91A0520	THOTA VEERA VENKATA RATNASAI	B.Tech-CSE	IV-II	T.V.V. Ratnasai
17	17T91A0521	PANCHADARLA RAMYA	B.Tech-CSE	IV-II	Panchadarla Ramya
18	17T91A0525	GAVARA PRIYANKA	B.Tech-CSE	IV-II	G. Priyanka
19	17T91A0526	MALIREDDY VASUDHA CHOWDARY	B.Tech-CSE	IV-II	M.V. Chowdary
20	17T91A0527	M V NAGA DATTHATHREYA KIRMANI	B.Tech-CSE	IV-II	V. Chowdary
21	17T91A0530	BALAM SUREKHA	B.Tech-CSE	IV-II	B. Surekha
22	17T91A0531	YADALA DIVYAMALA	B.Tech-CSE	IV-II	Y. Divya Mala
23	17T91A0532	BUNGA SUSMI HARSHITHA	B.Tech-CSE	IV-II	B. Susmi Harshitha
24	17T91A0534	PACHIPALA BHARATH KUMAR	B.Tech-CSE	IV-II	P. BHARATH K.
25	17T91A0535	SIRIGIRI KONDAREDDY	B.Tech-CSE	IV-II	S. Kondareddy
26	17T91A0536	BODDAPATI SUMATHI	B.Tech-CSE	IV-II	B. Sumathi
	17T91A0537	CHIPPADA MOHAN SRI SURYA PRAKASH	B.Tech-CSE	IV-II	C.M.S.S. Prakash
28	17T91A0538	THOTA SAI RAKESH	B.Tech-CSE	IV-II	T. Sai Rakesh
29	17T91A0539	SARAGADAM SWARUPA	B.Tech-CSE	IV-II	S. Swarupa
30	17T91A0540	GORRE RENUKA	B.Tech-CSE	IV-II	G. Renuka
31	17T91A0541	INAKOTI SRINU	B.Tech-CSE	IV-II	I. Srinu
32	17T91A0542	BARLA CHAITANYA	B.Tech-CSE	IV-II	B. Chaitanya
33	17T91A0543	PEDDIREDDY NAGAVIJAY	B.Tech-CSE	IV-II	P.N. Vijay
34	17T95A0501	BONTHU BHAGYA RATNAM	B.Tech-CSE	IV-II	B. Bhagya Ratnam
35	18T95A0501	KONDURU SIVAPRASAD	B.Tech-CSE	IV-II	K. Sivaprasad
36	18T95A0502	NAGABHERI MURALIDHAR	B.Tech-CSE	IV-II	N. Muralidhar
37	18T95A0503	PADIMI SRISATYA DEVI	B.Tech-CSE	IV-II	P. Srisatya Devi
38	18T95A0504	RUDRAM SATISH KUMAR	B.Tech-CSE	IV-II	R. Satish Kumar

  
COORDINATOR

Principal  
GIET ENGINEERING COLLEGE,  
NH-16, Chaitanya Knowledge City,  
RAJAHMUNDRY - 533 296.

  
HOD



## GIET ENGINEERING COLLEGE

NH - 16, Chaitanya Knowledge City, GIET Campus, Rajamahendravaram,  
Andhra Pradesh - 533296. Website: <http://www.gietee.ac.in> Email: [principalgec@giet.ac.in](mailto:principalgec@giet.ac.in)

(2020-21)  
4-2 Gen  
①

### DEPARTMENT OF COMPUTER SCIENCE AND ENGINEERING

#### Day wise attendance

S.NO	PIN NO	NAME OF THE STUDENT	22.02.2021	23.02.2021	24.02.2021	25.02.2021	26.02.2021	27.02.2021	1.03.2021	2.03.2021	3.03.2021	4.03.2021	5.03.2021	6.03.2021
1	17MUIA0553	GANNAMANI A V SRIRAM	P	P	P	A	P	P	P	P	P	P	P	P
2	16T91A0536	SANGISETTI DIVYA	P	P	P	P	P	P	P	A	P	P	A	P
3	16T91A0552	NALLA GOVIND	P	P	P	P	P	P	P	P	P	P	P	P
4	17T91A0501	BICCAVOLU TULASI	P	A	P	P	P	A	P	P	A	P	P	P
5	17T91A0502	CHIKKALA JAHNAVI	P	P	P	P	P	P	P	P	P	P	P	P
6	17T91A0503	GEDELA THRIMURTHULU	P	P	P	P	P	P	P	P	P	P	P	P
7	17T91A0504	SUNKESWARAM SRINIVASULU	P	P	P	A	P	P	A	P	P	A	P	P
8	17T91A0505	KARRI VEERABABU	P	P	P	P	P	P	P	P	P	P	P	P
9	17T91A0506	KOLLU SATHISH	P	P	P	P	P	P	P	P	P	P	P	P
10	17T91A0507	KOLLU LAHARI GEETHIKA	P	P	P	P	P	A	P	P	P	P	P	P
11	17T91A0509	KUTI VEERA VENKATA CHAKRAVARTHI	P	P	P	P	P	P	P	A	P	P	P	P
12	17T91A0510	M A P VENKATA SAI PHANEENDRA	P	P	P	P	P	P	P	P	P	P	P	P
13	17T91A0512	KADAVAKOLLU SADVIKA LAKSHMI	P	P	P	A	P	P	P	A	P	P	P	P
14	17T91A0514	PULIGUNDLA S S SUDESHNA	P	A	P	P	P	P	P	P	P	A	P	P
15	17T91A0515	RAMANOJU AKHILA RANI	P	P	A	P	P	P	P	P	P	P	P	P
16	17T91A0520	THOTA VEERA VENKATA RATNASAI	P	A	P	P	P	A	P	P	P	P	P	P
17	17T91A0521	PANCHADARLA RAMYA	P	P	P	P	P	P	P	P	P	P	P	P
18	17T91A0525	GAVARA PRIYANKA	P	P	P	P	P	P	P	P	P	P	P	P
19	17T91A0526	MALIREDDY VASUDHA CHOWDARY	P	P	P	P	A	P	P	P	P	P	P	P
20	17T91A0527	M V NAGA DATTHATHREYA KIRMANI	A	P	P	P	P	P	P	P	P	P	P	P
21	17T91A0530	BALAM SUREKHA	P	P	P	A	P	P	P	P	P	P	P	P
22	17T91A0531	YADALA DIVYAMALA	P	P	P	P	P	P	P	P	P	P	P	P
23	17T91A0532	BUNGA SUSMI HARSHITHA	P	P	P	P	P	P	P	A	P	P	P	P
24	17T91A0534	PACHIPALA BHARATH KUMAR	P	P	A	P	P	P	P	P	P	P	P	P
25	17T91A0535	SIRIGIRI KONDAREDDY	P	P	P	P	P	P	P	P	P	P	P	P
26	17T91A0536	BODDAPATI SUMATHI	P	P	A	P	P	P	P	P	P	P	P	P
27	17T91A0537	CHIPPADA MOHAN SRI SURYA PRAKASH	P	A	P	P	P	P	P	P	P	P	P	P
28	17T91A0538	THOTA SAI RAKESH	P	P	P	P	P	P	A	A	P	P	P	P
29	17T91A0539	SARAGADAM SWARUPA	P	P	P	P	P	P	P	P	P	P	A	P

Principal  
GIET ENGINEERING COLLEGE,  
NH-16, Chaitanya Knowledge City,  
RAJAHMUNDRY-533 296.

30	17T91A0540	GORRE RENUKA	P	A	P	A	A	P	P	P	P	D	D	D
31	17T91A0541	INAKOTI SRINU	P	A	A	A	A	D	P	P	P	P	P	P
32	17T91A0542	BARLA CHAITANYA	P	A	P	P	P	P	A	A	P	P	P	P
33	17T91A0543	PEDDIREDDY NAGAVIJAY	A	A	A	P	A	P	P	A	P	P	P	P
34	17T95A0501	BONTHU BHAGYA RATNAM	P	A	P	A	P	A	P	A	P	P	P	P
35	18T95A0501	KONDURU SIVAPRASAD	A	A	P	A	P	P	P	P	P	P	P	P
36	18T95A0502	NAGABHERI MURALIDHAR	P	A	P	P	A	D	P	P	P	P	P	P
37	18T95A0503	PADIMI SRISATYA DEVI	P	A	P	P	A	A	P	P	P	P	P	P
38	18T95A0504	RUDRAM SATISH KUMAR	P	A	P	P	P	P	P	A	P	P	P	P

(1)  
2020-21  
11/18/20

  
Program Coordinator

  
Principal  
GIET ENGINEERING COLLEGE,  
NH-16, Chaitanya Knowledge City,  
RAJAHMUNDRY - 533 296.

  
HOD



## GIET ENGINEERING COLLEGE

NH-16, Chaitanya Knowledge City, GIET Campus, Rajamahendravaram,  
Andhra Pradesh - 533296 Website: <http://www.gietec.ac.in> Email: [principalgec@giet.ac.in](mailto:principalgec@giet.ac.in)

Date: 09.03.2021

### PROGRAM REPORT

Name of the Program	:	A Certificate Program on Block chain Technology and its Applications”.
Date/Duration	:	22.02.2021 to 7.03.2021 (Two Week).
Resource Person	:	Dr. S. K. Meera Sharif, Head of the Department, CSE, GIET ENGINEERING COLLEGE. Rajahmundry, A.P Phone: 9490790137 Mail: <a href="mailto:sharif@giet.ac.in">sharif@giet.ac.in</a>
Name of the Coordinator	:	Ms. B. Sai Deepthi, Assistant Professor, CSE.
No of the Participants	:	38
Program Objective	:	<ul style="list-style-type: none"><li>• To provide conceptual understanding of the function of Block chain as a method of securing distributed ledgers, how consensus on their contents is achieved, and the new applications that they enable</li><li>• To cover the technological underpinnings of block chain operations as distributed data structures and decision-making systems, their functionality and different architecture types</li><li>• To provide a critical evaluation of existing “smart contract” capabilities and platforms, and examine their future directions, opportunities, risks and challenges.</li></ul>

  
Principal  
GIET ENGINEERING COLLEGE,  
NH-16, Chaitanya Knowledge City,  
RAJAHMUNDRY-533 296.



## GIET ENGINEERING COLLEGE

NH-16, Chaitanya Knowledge City, GIET Campus, Rajamahendravaram,  
Andhra Pradesh-533296 Website: <http://www.gietec.ac.in> Email: [principalgec@giet.ac.in](mailto:principalgec@giet.ac.in)

---

Program Outcome :

- The students would understand the structure of a block chain and why/when it is better than a simple distributed database
- Analyze the incentive structure in a blockchain based system and critically assess its functions, benefits and vulnerabilities
- Evaluate the setting where a block chain based structure may be applied, its potential and its limitations and understand what constitutes a “smart” contract, what are its legal implications and what it can and cannot do, now and in the near future

  
**Coordinator**

  
Principal  
GIET ENGINEERING COLLEGE,  
NH-16, Chaitanya Knowledge City,  
RAJAHMUNDRY - 533 296.

  
**HOD**



# GIET ENGINEERING COLLEGE

Approved by AICTE, New Delhi/Affiliated to JNTUK, Kakinada/Accredited by NAAC  
NH-16, Chaitanya Knowledge City, GIET Campus, Rajamahendravaram-533296, AP, India.  
Phone: 96529 29111, Website: [www.gietec.ac.in](http://www.gietec.ac.in), Email: [principalgec@giet.ac.in](mailto:principalgec@giet.ac.in)

## CERTIFICATE

Certified that Mr./Ms. BALAM SUREKHA

bearing the PIN 17T91A0530 studying IV B.Tech./MBA in the

department of CSE has attended the add-on/certificate course on

Block-chain Technology and its Applications from 22-02-2021 to

07-03-2021 during the academic year 2020-2021. He/She is advised to

maintain the same spirit in his/her future endeavors.

  
Coordinator

  
HOD

  
Principal  
GIET ENGINEERING COLLEGE,  
NH-16, Chaitanya Knowledge City,  
RAJAHMUNDRY-533 296.

  
Principal



# GIET ENGINEERING COLLEGE

Approved by AICTE, New Delhi/Affiliated to JNTUK, Kakinada/Accredited by NAAC  
NH-16, Chaitanya Knowledge City, GIET Campus, Rajamahendravaram-533296, AP, India.  
Phone: 96529 29111, Website: [www.gietec.ac.in](http://www.gietec.ac.in), Email: [principalgec@giet.ac.in](mailto:principalgec@giet.ac.in)

## CERTIFICATE

Certified that Mr./Ms. KONDURU SIVAPRASAD  
bearing the PIN 18T95A0501 studying IV B.Tech./MBA in the  
department of CSE has attended the add-on/certificate course on  
Block-chain Technology and its Applications from 22-02-2021 to  
07-03-2021 during the academic year 2020-2021. He/ She is advised to  
maintain the same spirit in his/her future endeavors.

*[Signature]*  
Coordinator

*[Signature]*  
HOD

*[Signature]*  
Principal  
GIET ENGINEERING COLLEGE,  
NH-16, Chaitanya Knowledge City,  
RAJAHMUNDRY-533 296.

*[Signature]*  
Principal





# GIET ENGINEERING COLLEGE

Approved by AICTE, New Delhi/Affiliated to JNTUK, Kakinada/Accredited by NAAC  
NH-16, Chaitanya Knowledge City, GIET Campus, Rajamahendravaram-533296, AP, India.  
Phone: 96529 29111, Website: [www.gietec.ac.in](http://www.gietec.ac.in), Email: [principalgec@giet.ac.in](mailto:principalgec@giet.ac.in)

## CERTIFICATE

Certified that Mr./Ms. GAVARA PRIYANKA

bearing the PIN 17T91A0525 studying IV B.Tech./MBA in the  
department of CSE has attended the add-on/certificate course on

Block-chain Technology and its Applications from 22-02-2021 to  
07-03-2021 during the academic year 2020-2021. He/ She is advised to

maintain the same spirit in his/her future endeavors.

  
Coordinator

  
HOD

  
Principal  
GIET ENGINEERING COLLEGE,  
NH-16, Chaitanya Knowledge City,  
RAJAHMUNDRY-533 296.

  
Principal.



# GIET ENGINEERING COLLEGE

Approved by AICTE, New Delhi/Affiliated to JNTUK, Kakinada/Accredited by NAAC  
NH-16, Chaitanya Knowledge City, GIET Campus, Rajamahendravaram-533296, AP, India.  
Phone: 96529 29111, Website: [www.gietec.ac.in](http://www.gietec.ac.in), Email: [principalgec@giet.ac.in](mailto:principalgec@giet.ac.in)

## CERTIFICATE

Certified that Mr./Ms. KOLLU SATHISH

bearing the PIN 17791A0506 studying IV B.Tech./MBA in the

department of CSE has attended the add-on/certificate course on

Block - chain Technology and its Applications from 22-02-2021 to

07-03-2021 during the academic year 2020 - 2021. He/ She is advised to

maintain the same spirit in his/~~her~~ future endeavors.

  
Coordinator

  
HOD

  
Principal  
GIET ENGINEERING COLLEGE,  
NH-16, Chaitanya Knowledge City,  
RAJAHMUNDRY-533 296.

  
Principal



# GIET ENGINEERING COLLEGE

Approved by AICTE, New Delhi/Affiliated to JNTUK, Kakinada/Accredited by NAAC  
NH-16, Chaitanya Knowledge City, GIET Campus, Rajamahendravaram-533296, AP, India.  
Phone: 96529 29111, Website: [www.gietec.ac.in](http://www.gietec.ac.in), Email: [principalgec@giet.ac.in](mailto:principalgec@giet.ac.in)

## CERTIFICATE

Certified that Mr./Ms. RAMANOJU AKHILA RANI

bearing the PIN 17T91A0515 studying IV B.Tech./MBA in the

department of CSF has attended the add-on/certificate course on

Block-Chain Technology and its Applications from 22-02-2021 to

07-03-2021 during the academic year 2020-2021. He/ She is advised to

maintain the same spirit in ~~his~~/her future endeavors.

  
Coordinator

  
HOD

  
Principal  
GIET ENGINEERING COLLEGE,  
NH-16, Chaitanya Knowledge City,  
RAJAHMUNDRY-533 296.

  
Principal

## Organising Committee

### Chief Patron

Shri. KVV Satyanarayana Raju  
Chairman, Chaitanya Group

### Patrons

Shri. K. Sasi Kiran Varma  
Vice-chairman, Chaitanya Group  
Smt. K. V. V. Lakshmi  
Executive Director, Chaitanya Group

### Co-Patrons

Dr. D. L. N. Raju  
CEO, Chaitanya Group  
Dr.P. Subba Raju  
General Manager, GIET Institutions

### Chairperson

Dr.S. Suryanarayana Raju  
Principal, GIET Engineering College

### Convener

Mr. B. Vamsi Krishna  
Head of the department,  
Department of Electrical and Electronics  
Engineering  
Email: [eee.gec@giet.ac.in](mailto:eee.gec@giet.ac.in)

### Co-ordinator

#### Mr.M.N.Saidulla

Assistant Professor,  
Department of Electrical and Electronics  
Engineering  
Mobile No: 9966348910  
Email id: mnsaidulla@gmail.com

## A Two Week Certificate Program on "HOMEWIRING"

### REGISTRATION FORM

1. Name of the Participant:
2. Class:
3. Roll Number:
4. Academic Year:
5. Branch:
6. Phone Number:
7. Email ID:
8. Address for Communication:
9. Signature of Participant:
10. Signature of class teacher:
11. Remarks (if any)

Date:  
Station:

  
Principal  
GIET ENGINEERING COLLEGE,  
NH-16, Chaitanya Knowledge City,  
RAJAHMUNDRY-

HOD



## A Two Week Certificate Program on "HOMEWIRING"

22.02.2021 to 07.03.2021



Organized  
by

DEPARTMENT OF  
ELECTRICAL AND ELECTRONICS ENGINEERING  
**GIET ENGINEERING COLLEGE**

(Formerly Known as Chaitanya Institute of Engineering & Technology)  
Approved by AICTE | Affiliated to JNTUK, Kakinada | Accredited by NAAC

NH-16, Chaitanya Knowledge City, GIET  
Campus, Rajamahendravaram, AP.

### About the Institute

The college is located at Chaitanya Nagar on NH-16 on the outskirts of Rajamahendravaram, in GIET campus. GIET Engineering College is an epitome of excellence in every aspect. Institute is Approved by AICTE and affiliated to JNTUK, Kakinada, Andhra Pradesh.

The Institute got accredited by NAAC. The institute offers undergraduate programs in diverse engineering streams. It features state-of-the-art facilities and a highly qualified and knowledgeable pool of staff members. apart from the prescribed course curriculum, the institute offers an entire educational experience with greater exposure of students advanced skill learning via existing centres of excellence. It has been a pioneer in adopting several pedagogic innovations for the benefit of students. The achievements of the students of this institution in academics as well as placements stand testimony to the fact.



### About the Department

The department of Electrical and Electronics Engineering was established in the year 2009 with an initial intake of 60 students. The UG program of the department of Electrical and Electronics Engineering imparts solid technical background and research capabilities among the students which help them to excel in their respective fields.

It has an array of courses for students to choose from and study such as Electrical and Electronics Engineering, Electronic devices, Power Systems, Electrical Machines, Control Systems Microcontroller, electrical circuit analysis, Power systems operations and controlling, Digital Electronics, Digital Signal Processing, Digital Control Systems, Electro Static Field, Utilization Of Electrical Energy.. and More.

The quality teaching and guidance by highly experienced faculty members provide the best quality educational experience to the students. The regular interaction between students and faculty helps a student to apply theoretical knowledge to real-life situations. Moreover, the faculty members organize special sessions for topics such as electronics, control system, networking, etc. that assures their placement in renowned multinational companies.

### About the Program

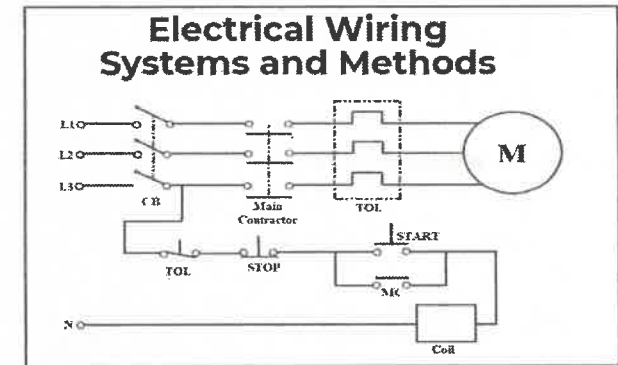

**Objectives of the Program:** Describe the basics of operating and setting up electrical wiring systems. Identify types and ratings of electrical wiring system. Understand the importance of fulfilling the requirements for safe use of electrical equipment and systems. Study electrical system testing procedures. Conduct spot checks and verification measures that need to be carried out in an electrical installation as required for compliance purposes Draw up simple operational policies for safety guidelines. Develop realistic maintenance strategies for electrical wiring system

**Resource Person**

**Mr. G. Venkateswara Rao**

Assistant Professor ,

GIET Engineering college

Email.id: [venky@giet.ac.in](mailto:venky@giet.ac.in)

Contact number: 8520098626



## GIET ENGINEERING COLLEGE

NH 16, Chaitanya Knowledge City, GIET Campus, Rajamahendravaram,  
Andhra Pradesh - 533296 Website: <http://www.gietec.ac.in> Email: [principal@giet.ac.in](mailto:principal@giet.ac.in)

### LIST OF STUDENTS ENROLLED FOR A TWO WEEK CERTIFICATE PROGRAM ON HOMEWIRING

S.NO	PIN NO	NAME OF THE STUDENT	PROGRAM NAME	YEAR-SEMETER	SIGNATURE OF STUDENT
1	20T95A0201	SUPLA ANJALI	B.Tech-EEE	II-II	S. Anjali
2	20T95A0202	YATAM UMA VENKATA SAI PRAVEEN	B.Tech-EEE	II-II	Y. U.V.S. Praveen
3	20T95A0203	PONNADA SRAVANI	B.Tech-EEE	II-II	P. Sravan
4	20T95A0204	KUSI VEERA VENKATA CHANDRA MOULI	B.Tech-EEE	II-II	Mouli
5	20T95A0205	KANDIPILLI BHAVANI KRISHNA KISHORE	B.Tech-EEE	II-II	K.B.K. Kishore
6	20T95A0206	DOMMETI RAJESH	B.Tech-EEE	II-II	D. Rajesh
7	20T95A0207	RAVURI CHAKRIDHAR	B.Tech-EEE	II-II	R. Chakridhar
8	20T95A0208	BONTHADA HEMA KOTESWARA RAO	B.Tech-EEE	II-II	R. Hema Koteswara Rao
9	20T95A0209	VANGALAPUDI BHANU PRAKASH	B.Tech-EEE	II-II	V. B. Prakash
10	20T95A0210	MUNGAMURI RAJESH	B.Tech-EEE	II-II	M. Rajesh
11	20T95A0211	MANDARAPU SIRISHA	B.Tech-EEE	II-II	M. Sirisha
12	20T95A0212	PALLAGANI HEMANTH	B.Tech-EEE	II-II	P. Hemant
13	20T95A0213	MANGINA MANI TEJA KUMAR	B.Tech-EEE	II-II	M. Teja Kumar

  
Program Coordinator

  
Principal  
GIET ENGINEERING COLLEGE,  
NH-16, Chaitanya Knowledge City,  
RAJAHMUNDRY - 533 296.

  
HOD



## GIET ENGINEERING COLLEGE

NH-16, Chaitanya Knowledge City, GIET Campus, Rajamahendravaram,  
Andhra Pradesh-533296 Website: <http://www.gietee.ac.in> Email: [principalgeof@gietee.ac.in](mailto:principalgeof@gietee.ac.in)

### DEPARTMENT OF ELECTRICAL AND ELECTRONICS ENGINEERING

#### Day wise attendance

S.NO	PIN NO	NAME OF THE STUDENT	22.02.21	23.02.21	24.02.21	25.02.21	26.02.21	27.02.21	01.03.21	02.03.21	03.03.21	04.03.21	05.03.21	06.03.21
1	20T95A0201	SURLA ANJALI	P	A	P	P	P	P	P	P	A	P	P	A
2	20T95A0202	YATAM UMA VENKATA SAI PRAVEEN	P	A	P	P	P	A	A	A	P	P	P	P
3	20T95A0203	PONNADA SRAVANI	P	P	P	P	P	P	P	P	A	P	P	P
4	20T95A0204	KUSI VEERA VENKATA CHANDRA MOULI	P	P	P	P	A	P	P	P	P	P	P	P
5	20T95A0205	KANDIPILLI BHAVANI KRISHNA KISHORE	A	P	P	P	P	P	P	P	P	P	A	P
6	20T95A0206	DOMMETI RAJESH	P	P	P	P	P	P	P	P	P	P	P	P
7	20T95A0207	RAVURI CHAKKIDHAR	P	A	A	P	P	P	P	P	A	P	P	P
8	20T95A0208	BONTHADA HEMA KOTESWARA RAO	P	P	P	P	P	P	P	A	P	A	P	P
9	20T95A0209	VANGALAPUDI BHANU PRAKASH	P	P	P	A	A	P	P	P	P	P	P	P
10	20T95A0210	MUNGAMURI RAJESH	P	P	P	P	P	P	P	P	P	P	P	P
11	20T95A0211	MANDARAPU SIRISHA	P	P	P	P	P	A	A	P	P	P	P	P
12	20T95A0212	PALLAGANI HEMANTHI	P	P	P	P	P	P	A	A	P	P	A	P
13	20T95A0213	MANGINA MANI TEJA KUMAR	A	P	P	P	P	P	A	P	P	A	P	P

  
Program Coordinator

  
Principal  
GIET ENGINEERING COLLEGE,  
NH-16, Chaitanya Knowledge City,  
RAJAHMUNDRY - 533 296.

  
HOD



## **GIET ENGINEERING COLLEGE**

NH - 16, Chaitanya Knowledge City, GIET Campus, Rajamahendravaram,  
Andhra Pradesh - 533296 Website: <http://www.gietec.ac.in> Email: [principalgec@giet.ac.in](mailto:principalgec@giet.ac.in)

---

Date: 12.02.2021

### **PROGRAM REPORT**

**Name of the Event: A Two Week Certificate Program on HOMEWIRING**

**Date: 22.02.2021 to 07.03.2021**

**Resource Person: Mr. G. Venkateswara Rao**

Assitant Professor , GIET Engineering college

Email.id: venky@giet.ac.in

Contact number: 8520098626

**Name of the Coordinator: Mr.M.N.Saidulla**

**Number of students attended: 13**

**Venue: ELECTRICAL MACHINES Lab, GIET Engineering college**

**Objectives of the Program:**

- Describe the basics of operating and setting up electrical wiring systems
- Select suitable types and ratings of electrical wiring systems
- Understand the importance of fulfilling the requirements for safe use of electrical equipment and systems
- Comprehend various earthing mechanisms and its importance in safety
- Perform simple methods of calculating to check the suitability of conductors and protective earthing elements to guarantee safe operation

**Topics to be covered:**

- Earthing and its importance in safety
- Variety and installation of wiring systems
- Range and installation of electrical equipment and safety concerns
- Testing and verification
- Liquid and solid and dielectrics
- Insulation class and temperature evaluations

  
Principal  
GIET ENGINEERING COLLEGE,  
NH-16, Chaitanya Knowledge City,  
RAJAHMUNDRY-533 296.



- Computing the demand of electrical systems for suitable conductor sizing
- Methods adopted for system earthing
- The need for earthing of electrical systems
- At the load (protective earthing)
- Protective conductor
- At the source (system earthing)
- Equipotential bonding
- Earth fault loop impedance
- Computation of earth fault current
- Earth fault sensing techniques
- Limits of LV feeder lengths for appropriate earth fault recognition
- Fault protection against overcurrent
- Arrangement of electrical installation
- Switchboards
- Added protection by fusing current devices
- Safety against Undervoltage
- Safety against overvoltage
- Shield against fire threats due to arcing faults
- Control of electrical installation
- Sizing of conductors
- Installation
- Baths, showers, fixed containers
- Pools and tubs
- Case studies
- Sites containing baths, showers or other damp situations
- Visual inspection
- Testing

### Outcomes of the Program:

- At the end of this course, the student will be able to
1. Use appropriate electrician tools, wires, protective devices and wiring accessories.
  2. Rig up wiring diagrams using conduit system of wiring.
  3. Apply IS standards for electrical wiring.
  4. Prepare different types of wiring joints.

  
Coordinator

  
Principal  
GIET ENGINEERING COLLEGE,  
NH-16, Chaitanya Knowledge City,  
RAJAHMUNDRY - 533 296.

  
HOD-EEE



# GIET ENGINEERING COLLEGE

Approved by AICTE, New Delhi/Affiliated to JNTUK, Kakinada/Accredited by NAAC  
NH-16, Chaitanya Knowledge City, GIET Campus, Rajamahendravaram-533296, AP, India.  
Phone: 96529 29111, Website: [www.gietec.ac.in](http://www.gietec.ac.in), Email: [principalgec@giet.ac.in](mailto:principalgec@giet.ac.in)

## CERTIFICATE

Certified that Mr./Ms. B. Hema koteswara Rao

bearing the PIN 20T95A0208 studying II B.Tech./~~MBA~~ in the

department of EEE has attended the add-on/certificate course on

Home Wiring from 22-2-21 to

6-3-21 during the academic year 2020-2021. He/ ~~She~~ is advised to

maintain the same spirit in his/~~her~~ future endeavors.

MB  
Coordinator

B. J. K.  
HOD

Principal  
Principal  
GIET ENGINEERING COLLEGE,  
NH-16, Chaitanya Knowledge City,  
RAJAHMUNDRY-533 296.



# GIET ENGINEERING COLLEGE

Approved by AICTE, New Delhi/Affiliated to JNTUK, Kakinada/Accredited by NAAC  
NH-16, Chaitanya Knowledge City, GIET Campus, Rajamahendravaram-533296, AP, India.  
Phone: 96529 29111, Website: [www.gietec.ac.in](http://www.gietec.ac.in), Email: [principalgec@giet.ac.in](mailto:principalgec@giet.ac.in)

## CERTIFICATE

Certified that Mr./Ms. S. Anjali

bearing the PIN 20795A0201 studying II B.Tech./MBA in the

department of EEE has attended the add-on/certificate course on

Home Wiring. from 22-2-21 to

6-3-21 during the academic year 2020-2021. He/ She is advised to

maintain the same spirit in his/her future endeavors.

MS  
Coordinator

B. Lakshmi  
HOD

[Signature]  
Principal  
GIET ENGINEERING COLLEGE,  
NH-16, Chaitanya Knowledge City,  
RAJAHMUNDRY-533 296.

[Signature]  
Principal



# GIET ENGINEERING COLLEGE

Approved by AICTE, New Delhi/Affiliated to JNTUK, Kakinada/Accredited by NAAC  
NH-16, Chaitanya Knowledge City, GIET Campus, Rajamahendravaram-533296, AP, India.  
Phone: 96529 29111, Website: [www.gietec.ac.in](http://www.gietec.ac.in), Email: [principalgec@giet.ac.in](mailto:principalgec@giet.ac.in)

## CERTIFICATE

Certified that Mr./Ms. M. Teja kumar

bearing the PIN 20T95A0213 studying II B.Tech./MBA in the

department of FEE has attended the add-on/certificate course on

Home Wiring from 22-2-21 to

6-3-21 during the academic year 2020 - 2021. He/She is advised to

maintain the same spirit in his/her future endeavors.

M  
Coordinator

B. Veer  
HOD

ew  
Principal  
GIET ENGINEERING COLLEGE,  
NH-16, Chaitanya Knowledge City,  
RAJAHMUNDRY-533 296. Principal



# GIET ENGINEERING COLLEGE

Approved by AICTE, New Delhi/Affiliated to JNTUK, Kakinada/Accredited by NAAC  
NH-16, Chaitanya Knowledge City, GIET Campus, Rajamahendravaram-533296, AP, India.  
Phone: 96529 29111, Website: [www.gietec.ac.in](http://www.gietec.ac.in), Email: [principalgec@giet.ac.in](mailto:principalgec@giet.ac.in)

## CERTIFICATE

Certified that Mr./Ms. V. Bhanu Prakash

bearing the PIN 20T950209 studying II B.Tech./~~MBA~~ in the

department of EEE has attended the add-on/certificate course on

Home Wiring. from 22-2-21 to

6-3-21 during the academic year 2020-2021. He/~~She~~ is advised to

maintain the same spirit in his/~~her~~ future endeavors.

MS  
Coordinator

B. K. S.  
HOD

[Signature]  
Principal  
GIET ENGINEERING COLLEGE,  
NH-16, Chaitanya Knowledge City,  
RAJAHMUNDRY-533 296.

[Signature]  
Principal



# GIET ENGINEERING COLLEGE

Approved by AICTE, New Delhi/Affiliated to JNTUK, Kakinada/Accredited by NAAC  
NH-16, Chaitanya Knowledge City, GIET Campus, Rajamahendravaram-533296, AP, India.  
Phone: 96529 29111, Website: [www.gietec.ac.in](http://www.gietec.ac.in), Email: [principalgec@giet.ac.in](mailto:principalgec@giet.ac.in)

## CERTIFICATE

Certified that Mr./Ms. K.V.V. Chandra Mouli.

bearing the PIN 20795A0204 studying II B.Tech./MBA in the  
department of FEE

has attended the add-on/certificate course on  
Home Wiring from 22-2-21 to  
6-3-21 during the academic year 2020-2021. He/She is advised to

maintain the same spirit in his/her future endeavors.

Me  
Coordinator

B. Chit.  
HOD

[Signature]  
Principal  
GIET ENGINEERING COLLEGE,  
NH-16, Chaitanya Knowledge City,  
RAJAHMUNDRY-533 296.

### Organising Committee

#### Chief Patron

Shri. KVV Satyanarayana Raju  
Chairman, Chaitanya Group

#### Patrons

Shri. K. Sasi Kiran Varma  
Vice-chairman, Chaitanya Group  
Smt. K. V. V. Lakshmi  
Executive Director, Chaitanya Group

#### Co-Patrons

Dr. D. L. N. Raju  
CEO, Chaitanya Group  
P. Subba Raju  
General Manager, GIET Institutions

#### Chairperson

Dr.S. Suryanarayana Raju  
Principal, GIET Engineering College

#### Convener

Mr. Et. Chakarapani  
Head of the department,  
Department of Civil Engineering  
Email: [civil.gec@giet.ac.in](mailto:civil.gec@giet.ac.in)

#### Co-ordinator

Ms.Y Siri Chowdary  
Assistant Professor,  
Department of Civil Engineering  
Email: [sirichowdary524@gmail.com](mailto:sirichowdary524@gmail.com)

## A Two Week Add on Program on "Building Drafting using AUTOCAD"

### REGISTRATION FORM

1. Name of the Participant:
2. Class:
3. Roll Number:
4. Academic Year:
5. Branch:
6. Phone Number:
7. Email ID:
8. Address for Communication:
9. Signature of Participant:
10. Signature of class teacher:
11. Remarks (if any)

Date:  
Station:

  
Principal  
GIET ENGINEERING COLLEGE,  
NH-16, Chaitanya Knowledge City,  
RAJAHMUNDRY-533 001

HOD



## A Two Week Add on Program on "Building Drafting using AUTOCAD" 22.02.2021 to 06.03.2021



Organized  
by

DEPARTMENT OF  
CIVIL ENGINEERING

**GIET ENGINEERING COLLEGE**

(Formerly Known as Chaitanya Institute of Engineering & Technology)  
Approved by AICTE | Affiliated to JNTUK, Kakinada | Accredited by NAAC

NH-16, Chaitanya Knowledge City, GIET  
Campus, Rajamahendravaram, AP.

### About the Institute

The college is located at Chaitanya Nagar on NH-16 on the outskirts of Rajamahendravaram, in GIET campus. GIET Engineering College is an epitome of excellence in every aspect. Institute is Approved by AICTE and affiliated to JNTUK, Kakinada, Andhra Pradesh.

The Institute got accredited by NAAC. The institute offers undergraduate programs in diverse engineering streams. It features state-of-the-art facilities and a highly qualified and knowledgeable pool of staff members. Apart from the prescribed course curriculum, the institute offers an entire educational experience with greater exposure of students advanced skill learning via existing centres of excellence. It has been a pioneer in adopting several pedagogic innovations for the benefit of students. The achievements of the students of this institution in academics as well as placements stand testimony to the fact.



### About the Department

The The Department of Civil Engineering pulls out all stops to create outstanding engineers - with advanced teaching techniques and learning aids for undergraduate students. CIVIL ENGINEERING DEPARTMENT of the institute started functioning from the year 2008. Students are not only made experts in technical aspects but also in interpersonal skills, a vital ingredient to excel in the fast paced world..

To conduct Training camps and Seminars for the students to accustom them with the present modern technologies. To Create Research & Development wing to improve innovative skills of student community.

The quality teaching and guidance by highly experienced faculty members provide the best quality educational experience to the students. The regular interaction between students and faculty helps a student to apply theoretical knowledge to real-life situations. Moreover, the faculty members organize special sessions for topics such as modern technologies, Create Research & Development, etc. that assures their placement in renowned multinational companies.

### About the Program

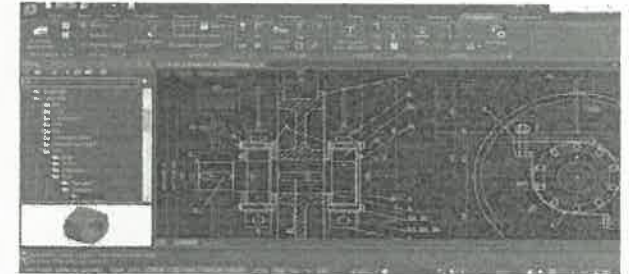

CAD or computer-aided design and drafting (CADD), is technology for design and technical documentation, which replaces manual drafting with an automated process. If you are a designer, drafter, architect or engineer, you have probably used 2D or 3D CAD programs such as AutoCAD or AutoCAD LT software. These widely used software programs can help you draft construction documentation, explore design ideas, visualise concepts through photorealistic renderings and simulate how a design performs in the real world...

### Resource Person

**Mr.AMN Kashyap**

Assistant Professor

GIET Engineering College,  
Rajahmundry.

Mobile No: 9491728149

Email id: kashyap@gmail.com





## GIET ENGINEERING COLLEGE

NH - 16, Chaitanya Knowledge City, GIET Campus, Rajamahendravaram,  
Andhra Pradesh - 533296 Website: <http://www.gietec.ac.in> Email: [principalgec@giet.ac.in](mailto:principalgec@giet.ac.in)

### List of students enrolled for Add-on Certificate Program on BUILDING DRAFTING USING AUTO CAD

S.NO	PIN NO	NAME OF THE STUDENT	PROGRAM NAME	YEAR-SEMETER	SIGNATURE OF STUDENT
1	19T91A0101	YARRAMPATI KANAKA DURGA KALYAN	B.Tech-CIVIL	II-I	Y. K. Puruga Kalyan
2	19T91A0102	YARLAGADDA ANIL	B.Tech-CIVIL	II-I	Y. Anil
3	19T91A0103	YANDAMURI V V SURYABRAHMAM	B.Tech-CIVIL	II-I	Y. V. V. Surya Brahmam
4	20T95A0101	YARRAMSETTI TARUN TEJA	B.Tech-CIVIL	II-I	Y. Teja
5	20T95A0102	KUNDRAPU SYAM KUMAR	B.Tech-CIVIL	II-I	K. Sam Kumar
6	20T95A0103	MARRAPU SIMHA JAGADEESH	B.Tech-CIVIL	II-I	M. S. Jagadeesh

  
COORDINATOR

  
HOD

  
Principal

GIET ENGINEERING COLLEGE,  
NH-16, Chaitanya Knowledge City,  
RAJAHMUNDRY - 533 296.



## GIET ENGINEERING COLLEGE

NH - 16, Chaitanya Knowledge City, GIET Campus, Rajamahendravaram,  
Andhra Pradesh - 533296 Website: <http://www.gietec.ac.in> Email: [principalgect@giet.ac.in](mailto:principalgect@giet.ac.in)

### DEPARTMENT OF CIVIL ENGINEERING

#### Day wise attendance .

S.NO	PIN NO	NAME OF THE STUDENT	22.02.2021	23.02.2021	24.02.2022	25.02.2022	26.02.2023	27.02.2023	01.03.2021	02.03.2021	03.03.2021	04.03.2021	05.03.2021	06.03.2021
1	19T91A0101	YARRAMPATI KANAKA DURGA KALYAN	A	P	A	P	P	P	P	P	A	P	P	P
2	19T91A0102	YARLAGADDA ANIL	P	P	P	P	A	P	P	P	P	P	P	P
3	19T91A0103	YANDAMURI V V SURYABRAHMAM	P	A	P	P	P	P	P	A	P	P	P	P
4	20T95A0101	YARRAMSETTI TARUN TEJA	P	P	P	P	P	A	A	P	P	A	A	A
5	20T95A0102	KUNDRAPU SYAM KUMAR	P	P	P	P	P	A	P	P	P	P	P	P
6	20T95A0103	MARRAPU SIMHA JAGADEESH	P	P	P	A	P	P	P	P	P	P	P	P

  
Coordinator

  
Principal  
GIET ENGINEERING COLLEGE,  
NH-16, Chaitanya Knowledge City,  
RAJAHMUNDRY - 533 296.

  
HOD



# GIET ENGINEERING COLLEGE

NH - 16, Chaitanya Knowledge City, GIET Campus, Rajamahendravaram,  
Andhra Pradesh - 533296 Website: <http://www.gietec.ac.in> Email: [principalgec@giet.ac.in](mailto:principalgec@giet.ac.in)

---

Date:09.03.2021

## PROGRAM REPORT

**Name of the Program** : “A Two-Week Certificate Program on BUILDING DRAFTING USING AUTO CAD”

**Date/Duration** : 22.02.2021 to 06.03.2021 (Two Week).

**Resource Person** : Mr.AMN Kashyap,  
Assistant professor,  
CE, GIET ENGINEERING COLLEGE.  
Rajahmundry, A.P

Phone:9491728149

Mail:kashyap@giet.ac.in

**Name of the Coordinator** : Ms.Y Siri Chowdary, Assistant Professor, CE.

**No of the Participants** : 06

**Program Objective** :

- Learn basic to advanced AUTOCAD
- The best courses for building a great profiles for higher study and jobs
- Participants can apply for LOR after the program
- Allows to draw and edit 2D and 3D designs
- Minimize human errors and helps the users to bring imagination to animation.

**Topics Covered**

- :The following topics are covered
- Introduction to AUTOCAD
  - Introduction to 3D and 3D solids
  - Extrude, loft, press

  
Principal  
GIET ENGINEERING COLLEGE,  
NH-16, Chaitanya Knowledge City,  
RAJAHMUNDRY-533 296.



## GIET ENGINEERING COLLEGE

NH - 16, Chaitanya Knowledge City, GIET Campus, Rajamahendravaram,  
Andhra Pradesh - 533296 Website: <http://www.gietec.ac.in> Email: [principalgec@giet.ac.in](mailto:principalgec@giet.ac.in)

---

- Dynamic UCS, selection plane

### Program Outcome :

- .Easy to zoom in and zoom out and pan to other areas of drawing
- Easy to draw objects accurately with various options to set exact size
- Can see a 3D image of drawing and can rotate it to all angles.
- Identify and solve any problems with the design before production.

*Sridi*  
**Coordinator**

*[Signature]*  
Principal  
GIET ENGINEERING COLLEGE,  
NH-16, Chaitanya Knowledge City,  
RAJAHMUNDRY - 533 296.

*[Signature]*  
**HOD**



# GIET ENGINEERING COLLEGE

Approved by AICTE, New Delhi/Affiliated to JNTUK, Kakinada/Accredited by NAAC  
NH-16, Chaitanya Knowledge City, GIET Campus, Rajamahendravaram-533296, AP, India.  
Phone: 96529 29111, Website: [www.gietec.ac.in](http://www.gietec.ac.in), Email: [principalgec@giet.ac.in](mailto:principalgec@giet.ac.in)

## CERTIFICATE

Certified that Mr./Ms. YARLAGADDA ANIL

bearing the PIN 19791A0102 studying II B.Tech./MBA in the

department of CIVIL has attended the add-on/certificate course on

BUILDING DRAFTING USING AUTO CAD

from 22/02/2021 to

6/3/2022 during the academic year 2020-2021. He/She is advised to

maintain the same spirit in his/her future endeavors.

*Siv*  
Coordinator

*SC*  
HOD

*Principal*  
Principal  
GIET ENGINEERING COLLEGE,  
NH-16, Chaitanya Knowledge City,  
RAJAHMUNDRY-533 296.

*Principal*  
Principal



# GIET ENGINEERING COLLEGE

Approved by AICTE, New Delhi/Affiliated to JNTUK, Kakinada/Accredited by NAAC  
NH-16, Chaitanya Knowledge City, GIET Campus, Rajamahendravaram-533296, AP, India.  
Phone: 96529 29111, Website: [www.gietec.ac.in](http://www.gietec.ac.in), Email: [principalgec@giet.ac.in](mailto:principalgec@giet.ac.in)

## CERTIFICATE

Certified that Mr./Ms. YANDAMURI V V SURYABRAHMAM

bearing the PIN 19791A0103 studying II B.Tech./MBA in the

department of CIVIL has attended the add-on/certificate course on

BUILDING DRAFTING USING AUTO CAD from 22/2/2021 to

6/3/2021 during the academic year 2020-2021. He/ She is advised to

maintain the same spirit in his/her future endeavors.

*Sini*  
Coordinator

*[Signature]*  
HOD

*[Signature]*  
Principal  
GIET ENGINEERING COLLEGE,  
NH-16, Chaitanya Knowledge City,  
RAJAHMUNDRY-533 296.

*[Signature]*  
Principal



# GIET ENGINEERING COLLEGE

Approved by AICTE, New Delhi/Affiliated to JNTUK, Kakinada/Accredited by NAAC  
NH-16, Chaitanya Knowledge City, GIET Campus, Rajamahendravaram-533296, AP, India.  
Phone: 96529 29111, Website: [www.gietec.ac.in](http://www.gietec.ac.in), Email: [principalgec@giet.ac.in](mailto:principalgec@giet.ac.in)

## CERTIFICATE

Certified that Mr./Ms. YARRAMSETTI TARUN TEJA

bearing the PIN 20T95A0101 studying II B.Tech./MBA in the

department of CIVIL has attended the add-on/certificate course on

BUILDING DRAFTING USING AUTO CAD from 22/02/2021 to

06/31/2021 during the academic year 2020-2021. He/She is advised to

maintain the same spirit in his/her future endeavors.

*Swi*  
Coordinator

*J*  
HOD

*Principal*  
Principal  
GIET ENGINEERING COLLEGE,  
NH-16, Chaitanya Knowledge City,  
RAJAHMUNDRY-533 296.

*Principal*  
Principal



# GIET ENGINEERING COLLEGE

Approved by AICTE, New Delhi/Affiliated to JNTUK, Kakinada/Accredited by NAAC  
NH-16, Chaitanya Knowledge City, GIET Campus, Rajamahendravaram-533296, AP, India.  
Phone: 96529 29111, Website: [www.gietec.ac.in](http://www.gietec.ac.in), Email: [principalgec@giet.ac.in](mailto:principalgec@giet.ac.in)

## CERTIFICATE

Certified that Mr./Ms. KUNDRAPU SYAM KUMAR

bearing the PIN 20T95A0103 studying II B.Tech./MBA in the

department of CIVIL has attended the add-on/certificate course on

BUILDING DRAFTING USING AUTO CAD from 22/2/2021 to

6/3/2021 during the academic year 2020-2021. He/ She is advised to

maintain the same spirit in his/her future endeavors.

Sri  
Coordinator

  
HOD

  
Principal  
GIET ENGINEERING COLLEGE,  
NH-16, Chaitanya Knowledge City,  
RAJAHMUNDRY-533 296.

  
Principal





# GIET ENGINEERING COLLEGE

Approved by AICTE, New Delhi/Affiliated to JNTUK, Kakinada/Accredited by NAAC  
NH-16, Chaitanya Knowledge City, GIET Campus, Rajamahendravaram-533296, AP, India.  
Phone: 96529 29111, Website: [www.gietec.ac.in](http://www.gietec.ac.in), Email: [principalgec@giet.ac.in](mailto:principalgec@giet.ac.in)

## CERTIFICATE

Certified that Mr./Ms. 20 MARRAPU SIMHA JAGADEESH

bearing the PIN 20795A0103 studying II B.Tech./ MBA in the

department of CIVIL has attended the add-on/certificate course on

BUILDING DRAFTING USING AUTO CAD

from 22/2/2021 to

6/3/2021 during the academic year 2020-2021

. He/ She is advised to

maintain the same spirit in his/her future endeavors.

Sri  
Coordinator

  
HOD

  
Principal  
GIET ENGINEERING COLLEGE,  
NH-16, Chaitanya Knowledge City,  
RAJAHMUNDRY-533 296.

  
Principal

## Organising Committee

### Chief Patron

Shri. KVV Satyanarayana Raju  
Chairman, Chaitanya Group

### Patrons

Shri. K. Sasi Kiran Varma  
Vice-chairman, Chaitanya Group  
Smt. K. V. V. Lakshmi  
Executive Director, Chaitanya Group

### Co-Patrons

Dr. D. L. N. Raju  
CEO, Chaitanya Group  
P. Subba Raju  
General Manager, GIET Institutions

### Chairperson

Dr. T. Vamsee Kiran  
Principal, GIET Engineering College

### Convener

Dr. B. Jagdeesh  
Head of the department,  
Department of Electronics and Communication  
Engineering  
Email: [ece.gec@giet.ac.in](mailto:ece.gec@giet.ac.in)

### Co-ordinator

Mr.K. V. Ramana,  
Assistant Professor,  
Department of Electronics and Communication  
Engineering  
Mobile No:9010817447  
Email id: [kvvenkataramana@giet.ac.in](mailto:kvvenkataramana@giet.ac.in)

## A Two Week Add on Program on "Python programming"

### REGISTRATION FORM

1. Name of the Participant:
2. Class:
3. Roll Number:
4. Academic Year:
5. Branch:
4. Phone Number:
5. Email ID:
6. Address for Communication:
9. Signature of Participant:
10. Signature of class teacher:
11. Remarks (if any)

Date:  
Station:

  
Principal  
GIET ENGINEERING COLLEGE,  
NH-16, Chaitanya Knowledge City,  
RAJAHMUNDRY-533 296.

HOD



## A Two Week Add on Program on "Python programming" 24.02.2021 to 09.03.2021



Organized  
by

DEPARTMENT OF  
ELECTRONICS AND COMMUNICATION  
ENGINEERING

**GIET ENGINEERING COLLEGE**

(Formerly Known as Chaitanya Institute of Engineering & Technology)  
Approved by AICTE | Affiliated to JNTUK, Kakinada | Accredited by NAAC

NH-16, Chaitanya Knowledge City, GIET  
Campus, Rajamahendravaram, AP.

### About the Institute

The college is located at Chaitanya Nagar on NH-16 on the outskirts of Rajamahendravaram, in GIET campus. GIET Engineering College is an epitome of excellence in every aspect. Institute is Approved by AICTE and affiliated to JNTUK, Kakinada, Andhra Pradesh.

The Institute got accredited by NAAC. The institute offers undergraduate programs in diverse engineering streams. It features state-of-the-art facilities and a highly qualified and knowledgeable pool of staff members apart from the prescribed course curriculum, the institute offers an entire educational experience with greater exposure of students advanced skill learning via existing centres of excellence. It has been a pioneer in adopting several pedagogic innovations for the benefit of students. The achievements of the students of this institution in academics as well as placements stand testimony to the fact.



### About the Department

The department of Electronics & Communication Engineering was established in the year 2005 with an initial intake of 60 students. The undergraduate program of the department of Electronics and Communication imparts solid technical background and research capabilities among the students which help them to excel in their respective fields.

It has an array of courses for students to choose from and study such as electronics, electronic hardware and software, communications, radio and television, solid state device, microelectronics, VLSI, and other circuits & systems used in varying applications ranging from simple circuits to sophisticated digital satellite systems, GSM & CDMA technology, speech processing & computer development.

The quality teaching and guidance by highly experienced faculty members provide the best quality educational experience to the students. The regular interaction between students and faculty helps a student to apply theoretical knowledge to real-life situations. Moreover, the faculty members organize special sessions for topics such as electronics, communication, control system, networking, etc. that assures their placement in renowned multinational companies.

### About the Program



Python is a dynamic, interpreted (bytecode-compiled) language. There are no type declarations of variables, parameters, functions, or methods in source code. This makes the code short and flexible, and you lose the compile-time type checking of the source code. Python tracks the types of all values at runtime and flags code that does not make sense as it runs. Python is a very popular general-purpose interpreted, interactive, object-oriented, and high-level programming language. Python is dynamically-typed and garbage-collected programming language. It was created by Guido van Rossum during 1985- 1990.

#### Resource Person

**Mr. K. Naga Raju**

Assistant Professor CSE,  
GIET Engineering College,  
Rajahmundry.

Mobile No: 7989648121

Email id:nagaraju@giet.ac.in



## GIET ENGINEERING COLLEGE

NH - 16, Chaitanya Knowledge City, GIET Campus, Rajamahendravaram,  
Andhra Pradesh - 533296 Website: <http://www.gietec.ac.in> Email: [principalgec@giet.ac.in](mailto:principalgec@giet.ac.in)

### List of students enrolled for A Two week Certificate Program on Python programming

S.NO	PIN NO	NAME OF THE STUDENT	PROGRAM NAME	YEAR-SEMETER	SIGNATURE OF STUDENT
1	16T91A0457	HEMADRIBHOTLA S S B SARAT KUMAR	B.Tech-ECE	IV-II	H.S.S.B Sarat Kumar
2	17T91A0401	ANNAM VENKATA BALAJI	B.Tech-ECE	IV-II	A. Balaji
3	17T91A0402	BANDARU GAYATHRI SOWMYA	B.Tech-ECE	IV-II	B.G. Sowmya
4	17T91A0403	BOMBOTHU BHAVANA SAI	B.Tech-ECE	IV-II	B. Bhavana
5	17T91A0404	BORRA N S S VARAPRASAD GOUD	B.Tech-ECE	IV-II	B. N. S. S. Varaprasad Goud
6	17T91A0405	CHIKKIREDDY MADHU KALYANI	B.Tech-ECE	IV-II	Ch. Madhu Kalyani
7	17T91A0406	KANDULA SAI	B.Tech-ECE	IV-II	K. Sai
8	17T91A0407	DIKSHA RANI	B.Tech-ECE	IV-II	Diksha Rani
9	17T91A0408	EDURURI SIVAKRISHNA	B.Tech-ECE	IV-II	E. Siva Krishna
10	17T91A0409	GANDREDDI DURGA SAI PRASAD	B.Tech-ECE	IV-II	G. D. S. Prasad
11	17T91A0410	GEDDAM DURGASATYAVATHI	B.Tech-ECE	IV-II	G. Durgasatyavathi
12	17T91A0411	GORUGANTHU LALITHA SRUTHI	B.Tech-ECE	IV-II	Gh. Sruthi
13	17T91A0413	INAKOTI SAI MAHESH	B.Tech-ECE	IV-II	P. Sai Mahesh
14	17T91A0414	JAKKA NAVEEN	B.Tech-ECE	IV-II	J. Naveen
15	17T91A0415	JONNALAGADDA REVANTH SREE SAI	B.Tech-ECE	IV-II	J. Revanth Sree Sai
16	17T91A0416	JUTTA JAGADEESWARI	B.Tech-ECE	IV-II	J. Jagadeeswari
17	17T91A0417	VEJALLA RAMAKRISHNA	B.Tech-ECE	IV-II	V. Rama Krishna
18	17T91A0418	YEDURESU GIRIDHAR	B.Tech-ECE	IV-II	Y. Giridhar
19	17T91A0420	KARRI DHANANJAYA REDDY	B.Tech-ECE	IV-II	Dhananjaya Reddy
20	17T91A0422	KOLLURI KRISHNA	B.Tech-ECE	IV-II	Krishna Kolluri
21	17T91A0423	KONAKALLA ALEKHYA	B.Tech-ECE	IV-II	K. Alekhya
22	17T91A0424	KOMMOJU PHANI SUMANTH	B.Tech-ECE	IV-II	K. Phani Sumanth
23	17T91A0425	KOPPISETTI GAYATHRILAKSHMI	B.Tech-ECE	IV-II	K. G. L. A. Varshini
24	17T91A0426	MANDAPAKA VENKATA SAI RAM	B.Tech-ECE	IV-II	M. V. Sai Ram
25	17T91A0428	VEMULA VEERANARAYANA	B.Tech-ECE	IV-II	V. Veeranarayan
26	17T91A0429	MERUPO SUSHMA SAROJA	B.Tech-ECE	IV-II	Sushma Sarojam
27	17T91A0431	MUPPANABOINA VENKATESH	B.Tech-ECE	IV-II	M. Venkatesh
28	17T91A0432	GUNDALA RAVI	B.Tech-ECE	IV-II	G. Ravi
29	17T91A0434	NIDAMARTHI SANDEEPKIRAN	B.Tech-ECE	IV-II	N. Sandeep
30	17T91A0435	PALINGI RAVITEJA	B.Tech-ECE	IV-II	P. Raviteja
31	17T91A0436	GRANDHI VENKATA NAGA DATTA	B.Tech-ECE	IV-II	G. V. N. Dattasatya
32	17T91A0437	PATCHA LEELA KRISHNA	B.Tech-ECE	IV-II	P. Leela Krishna
33	17T91A0438	PEDDINTI HARICHANDANA	B.Tech-ECE	IV-II	P. H. Chandana
34	17T91A0439	PUPPALA MURALIKRISHNA	B.Tech-ECE	IV-II	P. Murali Krishna
35	17T91A0440	PURETI MOHANA SANJU	B.Tech-ECE	IV-II	P. Mohana Sanju
36	17T91A0441	PURUSHOTAM ESWAR SAI TEJA	B.Tech-ECE	IV-II	P. Eswar Sai Teja
37	17T91A0442	PAIDI PURNA SATISH	B.Tech-ECE	IV-II	P. Purna Satish
38	17T91A0443	RAPAKA ASHA PRIYA	B.Tech-ECE	IV-II	R. Asha Priya
39	17T91A0444	REBBAGONDLA SEETHARAMAIAH	B.Tech-ECE	IV-II	R. Seetharamaiah
40	17T91A0445	SEESALA SRI LAKSHMI SAI DURGA	B.Tech-ECE	IV-II	S. Srilakshmi
41	17T91A0446	TAMMINEEDI SATYA SAI MANI TEJASWINI	B.Tech-ECE	IV-II	T. S. S. M. Tejaswini
42	17T91A0447	TURAGA V LAKSHMI MANIKYAMBA	B.Tech-ECE	IV-II	T. Lakshmi Manikyamba
43	17T91A0448	CHENNUBOINA V N DURGA DEVI	B.Tech-ECE	IV-II	Ch. V. N. Durga Devi
44	17T91A0449	UPPULURI NAGACHANDRA RAO	B.Tech-ECE	IV-II	U. Naga

Principal  
GIET ENGINEERING COLLEGE,  
NH-16, Chaitanya Knowledge City,  
RAJAHMUNDRY-533 296.

45	17T91A0451	BONDAPALLI DEENADAYAL	B.Tech-ECE	IV-II	B. Deena dayala
46	17T91A0452	SOMESH MOUKA	B.Tech-ECE	IV-II	PH
47	17T91A0453	ALLIMALLI VENKAT	B.Tech-ECE	IV-II	A. Venkat
48	17T91A0455	SANGANA KRISHNA BHARATH REDDY	B.Tech-ECE	IV-II	S. krishna
49	17T91A0456	VENNAPUSA PRASADREDDY	B.Tech-ECE	IV-II	V. prasad Reddy
50	17T91A0457	MEKA SRI SAI SHARATH	B.Tech-ECE	IV-II	M. Sri Sai Sharath
51	17T91A0458	BALABHADRA SAIRAM	B.Tech-ECE	IV-II	B. Sai ram
52	17T91A0459	KALLA BALAJI	B.Tech-ECE	IV-II	K. Balaji
53	17T91A0461	CHIKKALA SAI SIRI SRIJA	B.Tech-ECE	IV-II	Ch. Sai Siri Srija
54	17T91A0462	MALIREDDY SATYA VARALAKSHMI	B.Tech-ECE	IV-II	M. Satya varalakshmi
55	17T91A0464	SYPIREDDY K SURENDHRA KUMAR	B.Tech-ECE	IV-II	Surendhray
56	17T91A0465	GANGIREDDY SRAVANI	B.Tech-ECE	IV-II	G. Sravani
57	17T91A0467	LELLA SRINATH REDDY	B.Tech-ECE	IV-II	L. Srinath Reddy
58	18T95A0401	DONGA SAI SRUJAN	B.Tech-ECE	IV-II	D. Sai Srujan
59	18T95A0403	GONUGUNTA VIJAY KUMAR	B.Tech-ECE	IV-II	G. Vijay Kumar
60	18T95A0404	LOTLA MOHANKRISHNA	B.Tech-ECE	IV-II	L. Mohan
61	18T95A0405	NADIGATLA JAYASREE	B.Tech-ECE	IV-II	N. Jayasree
62	18T95A0406	NALI PREM KUMAR	B.Tech-ECE	IV-II	N. prem
63	18T95A0407	SIRIMISETTI KARUNAKAR	B.Tech-ECE	IV-II	K
64	18T95A0408	VEDURUPAKA SOMA SEKHAR	B.Tech-ECE	IV-II	V. S. Sekhar
65	18T95A0409	VELUGUBANTLA DURGA SRIRAM	B.Tech-ECE	IV-II	Ram

Program Coordinator



Principal

GIET ENGINEERING COLLEGE,  
NH-16, Chaitanya Knowledge City,  
RAJAHMUNDRY - 533 296.

HOD





## GIET ENGINEERING COLLEGE

NH - 16, Chaitanya Knowledge City, GIET Campus, Rajamahendravaram,  
Andhra Pradesh - 533296 Website: <http://www.gietec.ac.in> Email: [principal@giet.ac.in](mailto:principal@giet.ac.in)

### DEPARTMENT OF ELECTRONICS AND COMMUNICATIONS ENGINEERING

#### Day wise Attendance

S.NO	PIN NO	NAME OF THE STUDENT	24.02.2021	25.02.2021	26.02.2021	27.02.2021	01.03.2021	02.03.2021	03.03.2021	04.03.2021	06.03.2021	08.03.2021	09.03.2021
1	16T91A0457	HEMADRIBHOTLA S S B SARAT KUMAR	P	P	P	A	P	P	P	P	P	P	P
2	17T91A0401	ANNAM VENKATA BALAJI	P	P	P	P	P	P	P	P	P	P	P
3	17T91A0402	BANDARU GAYATHRI SOWMYA	P	P	P	P	P	P	P	P	P	P	P
4	17T91A0403	BOMBOTHU BHAVANA SAI	P	P	P	P	P	P	P	P	P	A	P
5	17T91A0404	BORRA N S S VARAPRASAD GOUD	P	P	P	P	P	A	P	P	P	P	P
6	17T91A0405	CHIKKIREDDY MADHU KALYANI	P	P	P	P	P	P	P	P	P	P	P
7	17T91A0406	KANDULA SAI	P	P	P	P	P	P	P	P	P	P	P
8	17T91A0407	DIKSHA RANI	A	P	P	P	P	P	P	P	A	P	P
9	17T91A0408	EDURURI SIVAKRISHNA	P	P	P	P	P	P	P	P	P	P	P
10	17T91A0409	GANDREDDI DURGA SAI PRASAD	P	P	P	P	P	P	P	A	P	P	P
11	17T91A0410	GEDDAM DURGASATYAVATHI	P	A	P	P	P	P	P	P	P	P	P
12	17T91A0411	GORUGANTHU LALITHA SRUTHI	P	P	A	P	P	P	P	P	P	P	P
13	17T91A0413	INAKOTI SAI MAHESH	P	P	P	P	P	P	P	P	P	P	P
14	17T91A0414	JAKKA NAVEEN	P	P	P	P	P	P	P	P	P	P	P
15	17T91A0415	JONNALAGADDA REVANTH SREE SAI	P	P	P	P	P	P	A	P	P	A	P
16	17T91A0416	JUTTA JAGADEESWARI	P	P	P	P	P	P	P	P	P	A	P
17	17T91A0417	VEJALLA RAMAKRISHNA	P	P	P	P	P	P	P	P	P	P	P
18	17T91A0418	YEDURESI GIRIDHAR	P	P	P	P	P	P	P	P	P	P	P
19	17T91A0420	KARRI DHANANJAYA REDDY	A	P	P	P	P	P	P	P	P	P	P
20	17T91A0422	KOLLURI KRISHNA	P	P	P	A	P	P	P	P	P	P	P
21	17T91A0423	KONAKALLA ALEKHYA	P	P	P	P	P	P	P	P	P	P	P
22	17T91A0424	KOMMOJU PHANI SUMANTH	P	P	P	P	P	P	P	A	P	P	P
23	17T91A0425	KOPPISETTI GAYATHRILAKSHMI	P	P	P	P	P	P	P	P	P	P	P
24	17T91A0426	MANDAPAKA VENKATA SAI RAM	P	A	P	P	P	A	P	P	A	P	P
25	17T91A0428	VEMULA VEERANARAYANA	P	P	P	P	A	P	P	P	P	P	P
26	17T91A0429	MERUPO SUSHMA SAROJA	P	P	P	P	A	P	P	P	P	P	P
27	17T91A0431	MUPPANABOINA VENKATESH	A	P	P	P	P	P	A	P	P	P	A
28	17T91A0432	GUNDALA RAVI	P	P	P	P	A	P	P	P	P	P	P
29	17T91A0434	NIDAMARTHI SANDEEPKIRAN	P	P	P	A	P	P	P	P	P	P	P

Principal  
GIET ENGINEERING COLLEGE,  
NH-16, Chaitanya Knowledge City,  
RAJAHMUNDRY-533

30	17T91A0435	PALINGI RAVITEJA	P	P	P	P	P	P	P	P	P	P	P
31	17T91A0436	GRANDHI VENKATA NAGA DATTA	P	P	P	P	P	P	P	P	P	P	P
32	17T91A0437	PATCHA LEELA KRISHNA	P	P	P	P	P	P	P	P	P	P	P
33	17T91A0438	PEDDINTI HARICHANDANA	P	P	P	P	P	P	P	P	P	P	P
34	17T91A0439	PUPPALA MURALIKRISHNA	P	P	P	P	P	P	P	P	P	P	P
35	17T91A0440	PURETI MOHANA SANJU	P	P	P	P	P	P	P	P	P	P	P
36	17T91A0441	PURUSHOTAM ESWAR SAI TEJA	P	P	P	P	P	P	P	P	P	P	P
37	17T91A0442	PAIDI PURNA SATISH	P	P	P	P	P	P	P	P	P	P	P
38	17T91A0443	RAPAKA ASHA PRIYA	P	P	P	P	P	P	P	P	P	P	P
39	17T91A0444	REBBAGONDLA SEETHARAMAIAH	P	P	P	P	P	P	P	P	P	P	P
40	17T91A0445	SEESALA SRI LAKSHMI SAI DURGA	P	P	P	P	P	P	P	P	P	P	P
41	17T91A0446	TAMMINEEDI SATYA SAI MANI TEJASWINI	P	P	P	P	P	P	P	P	P	P	P
42	17T91A0447	TURAGA V LAKSHMI MANIKYAMBA	P	P	P	P	P	P	P	P	P	P	P
43	17T91A0448	CHENNUBOINA V N DURGA DEVI	P	P	P	P	P	P	P	P	P	P	P
44	17T91A0449	UPPULURI NAGACHANDRA RAO	P	P	P	P	P	P	P	P	P	P	P
45	17T91A0451	BONDAPALLI DEENADAYAL	P	P	P	P	P	P	P	P	P	P	P
46	17T91A0452	SOMESH MOUKA	P	P	P	P	P	P	P	P	P	P	P
47	17T91A0453	ALLIMALLI VENKAT	P	P	P	P	P	P	P	P	P	P	P
48	17T91A0455	SANGANA KRISHNA BHARATH REDDY	P	P	P	P	P	P	P	P	P	P	P
49	17T91A0456	VENNAPUSA PRASADREDDY	P	P	P	P	P	P	P	P	P	P	P
50	17T91A0457	MEKA SRI SAI SHARATH	P	P	P	P	P	P	P	P	P	P	P
51	17T91A0458	BALABHADRA SAIRAM	P	P	P	P	P	P	P	P	P	P	P
52	17T91A0459	KALLA BALAJI	P	P	P	P	P	P	P	P	P	P	P
53	17T91A0461	CHIKKALA SAI SIRI SRIJA	P	P	P	P	P	P	P	P	P	P	P
54	17T91A0462	MALIREDDY SATYA VARALAKSHMI	P	P	P	P	P	P	P	P	P	P	P
55	17T91A0464	SYPIREDDY K SURENDHRA KUMAR	P	P	P	P	P	P	P	P	P	P	P
56	17T91A0465	GANGIREDDY SRAVANI	P	P	P	P	P	P	P	P	P	P	P
57	17T91A0467	LELLA SRINATH REDDY	P	P	P	P	P	P	P	P	P	P	P
58	18T95A0401	DONGA SAI SRUJAN	P	P	P	P	P	P	P	P	P	P	P
59	18T95A0403	GONUGUNTA VIJAY KUMAR	P	P	P	P	P	P	P	P	P	P	P
60	18T95A0404	LOTLA MOHANKRISHNA	P	P	P	P	P	P	P	P	P	P	P
61	18T95A0405	NADIGATLA JAYASREE	P	P	P	P	P	P	P	P	P	P	P
62	18T95A0406	NALI PREM KUMAR	P	P	P	P	P	P	P	P	P	P	P
63	18T95A0407	SIRIMISETTI KARUNAKAR	P	P	P	P	P	P	P	P	P	P	P
64	18T95A0408	VEDURUPAKA SOMA SEKHAR	P	P	P	P	P	P	P	P	P	P	P
65	18T95A0409	VELUGUBANTLA DURGA SRIRAM	P	P	P	P	P	P	P	P	P	P	P

Program Coordinator

Principal  
GIET ENGINEERING COLLEGE,  
NH-16, Chaitanya Knowledge City,  
RAJAHMUNDRY - 533 296.

HOD  
20-21  
Final year  
Phyton Project



# **GIET ENGINEERING COLLEGE**

NH - 16, Chaitanya Knowledge City, GIET Campus, Rajamahendravaram,  
Andhra Pradesh - 533296 Website: <http://www.gietec.ac.in> Email: [principalgec@giet.ac.in](mailto:principalgec@giet.ac.in)

---

Date: 12.03.2021

## **PROGRAM REPORT**

**Name of the Event: A Two week Certificate Program on Python programming**

**Date: 24.02.2021 to 09.03.2021**

**Resource Person: Mr.K.Naga Raju**

Assistant Professor CSE GIET Engineering college

Email.id: [nagaraju@giet.ac.in](mailto:nagaraju@giet.ac.in)

Contact number: 7989648121

**Name of the Coordinator: Mr.K.V.Ramana**

**Number of students attended: 65**

**Venue: Computer lab, Sir Arthur cotton block, GIET Engineering college**

### **Objectives of the Program:**

- Master the fundamentals of writing python scripts.
- Show how Python can be used to solve data science and machine learning problems from an industrial perspective.
- All the basic features of Python and will gradually move towards more advanced parts of Python programming.

Principal  
GIET ENGINEERING COLLEGE,  
NH-16, Chaitanya Knowledge City,  
RAJAHMUNDRY-533 296.



### Topics to be covered:

- Introduction & Basics of Python, Basic data types String
- Decision and control statements, loops
- Functions and recursion, List, Tuples
- Dictionaries, Sets, Exception and File Handling
- Modules, Packages, Object Oriented Programming
- Machine learning with Python
- Industry Perspective of Python & Applications

### Outcomes of the Program:

- At the end of this course, the student will be able to
1. Explain the basic principles of Python Programming language
  2. Implement object oriented concepts
  3. Implement data base and applications



**Coordinator**



**Principal**  
**GIET ENGINEERING COLLEGE,**  
NH-16, Chaitanya Knowledge City,  
RAJAHMUNDRY - 533 296.



**HOD-ECE**



# GIET ENGINEERING COLLEGE

Approved by AICTE, New Delhi/Affiliated to JNTUK, Kakinada/Accredited by NAAC  
NH-16, Chaitanya Knowledge City, GIET Campus, Rajamahendravaram-533296, AP, India.  
Phone: 96529 29111, Website: [www.gietec.ac.in](http://www.gietec.ac.in), Email: [principalgec@giet.ac.in](mailto:principalgec@giet.ac.in)

## CERTIFICATE

Certified that Mr./Ms. KALLA BALAJI

bearing the PIN 17791A0459 studying IV - II B.Tech./MBA in the

department of ECE has attended the add-on/certificate course on

PYTHON PROGRAMMING from 24-02-2021 to

09-03-2021 during the academic year 2020-21. He/ She is advised to

maintain the same spirit in his/her future endeavors.

  
Coordinator

  
HOD

  
Principal  
GIET ENGINEERING COLLEGE,  
NH-16, Chaitanya Knowledge City,  
RAJAHMUNDRY-533 296.

  
Principal



# GIET ENGINEERING COLLEGE

Approved by AICTE, New Delhi/Affiliated to JNTUK, Kakinada/Accredited by NAAC  
NH-16, Chaitanya Knowledge City, GIET Campus, Rajamahendravaram-533296, AP, India.  
Phone: 96529 29111, Website: [www.gietec.ac.in](http://www.gietec.ac.in), Email: [principalgec@giet.ac.in](mailto:principalgec@giet.ac.in)

## CERTIFICATE

Certified that Mr./Ms. NADI GATLA. JAYASREE

bearing the PIN 18T95A0405 studying IV - II B.Tech./ MBA in the

department of ECE has attended the add-on/certificate course on

PYTHON PROGRAMMING from 24-02-2021 to

09-03-2021 during the academic year 2020-21. He/ She is advised to

maintain the same spirit in his/her future endeavors.

  
Coordinator

  
HOD

  
Principal  
GIET ENGINEERING COLLEGE, Principal  
NH-16, Chaitanya Knowledge City,  
RAJAHMUNDRY-533 296.



# GIET ENGINEERING COLLEGE

Approved by AICTE, New Delhi/Affiliated to JNTUK, Kakinada/Accredited by NAAC  
NH-16, Chaitanya Knowledge City, GIET Campus, Rajamahendravaram-533296, AP, India.  
Phone: 96529 29111, Website: [www.gietec.ac.in](http://www.gietec.ac.in), Email: [principalgec@giet.ac.in](mailto:principalgec@giet.ac.in)

## CERTIFICATE

Certified that Mr./Ms. NALI . PREM KUMAR

bearing the PIN 18795A0406 studying IV - II B.Tech./MBA in the

department of ECE has attended the add-on/certificate course on



PYTHON PROGRAMMING from 24-02-2021 to

09-03-2021 during the academic year 2020-21. He/ She is advised to

maintain the same spirit in his/her future endeavors.

  
Coordinator

  
HOD

  
Principal  
GIET ENGINEERING COLLEGE,   
NH-16, Chaitanya Knowledge City,  
RAJAHMUNDRY-533 296.



# GIET ENGINEERING COLLEGE

Approved by AICTE, New Delhi/Affiliated to JNTUK, Kakinada/Accredited by NAAC  
NH-16, Chaitanya Knowledge City, GIET Campus, Rajamahendravaram-533296, AP, India.  
Phone: 96529 29111, Website: [www.gietec.ac.in](http://www.gietec.ac.in), Email: [principalgec@giet.ac.in](mailto:principalgec@giet.ac.in)

## CERTIFICATE

Certified that Mr./Ms. ALLIMALLI - VENKAT

bearing the PIN 17T91A0453 studying IV - II B.Tech./MBA in the

department of ECE has attended the add-on/certificate course on

PYTHON PROGRAMMING from 24-02-2021 to

09-03-2021 during the academic year 2020-21. He/ She is advised to

maintain the same spirit in his/her future endeavors.

  
Coordinator

  
HOD

  
Principal  
GIET ENGINEERING COLLEGE, Principal  
NH-16, Chaitanya Knowledge City,  
RAJAHMUNDRY-533 296.



# GIET ENGINEERING COLLEGE

Approved by AICTE, New Delhi/Affiliated to JNTUK, Kakinada/Accredited by NAAC  
NH-16, Chaitanya Knowledge City, GIET Campus, Rajamahendravaram-533296, AP, India.  
Phone: 96529 29111, Website: [www.gietec.ac.in](http://www.gietec.ac.in), Email: [principalgec@giet.ac.in](mailto:principalgec@giet.ac.in)

## CERTIFICATE

Certified that Mr./Ms. SOMESH. MOUKA

bearing the PIN 17T91A0452 studying IV - II B.Tech./ MBA in the

department of ECE has attended the add-on/certificate course on

PYTHON PROGRAMMING from 24-02-2021 to

09-03-2021 during the academic year 2020-21. He/ She is advised to

maintain the same spirit in his/her future endeavors.

  
Coordinator

  
HOD

  
Principal  
GIET ENGINEERING COLLEGE, Principal  
NH-16, Chaitanya Knowledge City,  
RAJAHMUNDRY-533 296.

**Organising Committee**

**Chief Patron**

Shri. KVV Satyanarayana Raju  
Chairman, Chaitanya Group

**Patrons**

Shri. K. Sasi Kiran Varma  
Vice-chairman, Chaitanya Group  
Smt. K. V. V. Lakshmi  
Executive Director, Chaitanya Group

**Co-Patrons**

Dr. D. L. N. Raju  
CEO, Chaitanya Group  
P. Subba Raju  
General Manager, GIET Institutions

**Chairperson**

Dr.T.Vamsee Kiran  
Principal, GIET Engineering College

**Convener**

Mr.A.V.Sridhar,  
Associate Professor,  
Department of Mechanical Engineering  
Mobile No: 9908942849  
Email iddrsridharav@gmail.com

**Co-ordinator**

Mr.V.Avinash  
Assistant Professor,  
Department of Mechanical Engineering  
Email:avinashvemagiri777@gmail.com

**A Two Week Add on Program on  
"Design and Controlling of Humanoid  
Robots"**

**REGISTRATION FORM**

1. Name of the Participant:
2. Class:
3. Roll Number:
4. Academic Year:
5. Branch:
6. Phone Number:
7. Email ID:
8. Address for Communication:
9. Signature of Participant:
10. Signature of class teacher:
11. Remarks (if any)

Date:  
Station:

  
Principal HOD  
GIET ENGINEERING COLLEGE,  
NH-16, Chaitanya Knowledge City,  
RAJAMAHENDRAVARAM, AP.



**A Two Week Add on Program on  
"Design and Controlling of Humanoid  
Robots"**

**24.02.2021 to 09.03.2021**



**Organized  
by  
DEPARTMENT OF  
MECHANICAL ENGINEERING  
GIET ENGINEERING COLLEGE**  
(Formerly Known as Chaitanya Institute of Engineering & Technology)  
Approved by AICTE | Affiliated to JNTUK, Kakinada | Accredited by NAAC

NH-16, Chaitanya Knowledge City, GIET  
Campus, Rajamahendravaram, AP.

### About the Institute

The college is located at Chaitanya Nagar on NH-16 on the outskirts of Rajamahendravaram, in GIET campus. GIET Engineering College is an epitome of excellence in every aspect. Institute is Approved by AICTE and affiliated to JNTUK, Kakinada, Andhra Pradesh.

The Institute got accredited by NAAC. The institute offers undergraduate programs in diverse engineering streams. It features state-of-the-art facilities and a highly qualified and knowledgeable pool of staff members. Apart from the prescribed course curriculum, the institute offers an entire educational experience with greater exposure of students advanced skill learning via existing centres of excellence. It has been a pioneer in adopting several pedagogic innovations for the benefit of students. The achievements of the students of this institution in academics as well as placements stand testimony to the fact.



### About the Department

Mechanical engineering is an evergreen discipline that involved in the application of basic science and mathematical principles to design, analyze, manufacture, and maintenance of mechanical systems. Mechanical engineers work across a huge variety of industries. Mechanical engineers are in the design, manufacture and maintenance of things ranging from a small safety pin to a giant ship. It is one of the oldest branches of engineering, it is also one that continues to change and grow with the advancements in technology making it a vibrant and exciting career path even to this day. The total number of engineers employed in the U.S. in 2015 was roughly 1.6 million. Of these 17.28% were mechanical engineers, the largest discipline by size.

The department is equipped with academically sound and experienced faculty specialized in various areas of mechanical engineering. The department is provided with state of are laboratories and software. In addition to the regular curriculum we conduct programs like add-on training programs on drafting, solid modelling, etc., Industrial visits, Seminars, Hands-on workshops on latest technologies to enhance the skills of the students to meet the demands of the industry.

### About the Program



In rapid change with technology a huge development of robots is competing equally with humans. The technology development has brought many changes in the field of manufacturing and research. Initially, the robots were used by humans to make their work easier, but today the robots are developed to replicate humans and substitute the labor in the fields where even human presence is difficult. The development doesn't only take place in the manufacturing of robots but simultaneously it focuses on control and optimization of the tasks that are done by the robots. The aspects of robots are unlimited in the field of medical, defense, education. The type of application defines the robots construction and the requirement of systems.

#### Resource Person

**Mr.K.V.G.Praveen**

Assistant Professor

GIET Engineering College,

Rajahmundry.

Mobile No:8499063164

Email id: kvgpraveen107@gmail.com





## GIET ENGINEERING COLLEGE

NH - 16, Chaitanya Knowledge City, GIET Campus, Rajamahendravaram,  
Andhra Pradesh - 533296 Website: <http://www.gietec.ac.in> Email: [principalgiet@giet.ac.in](mailto:principalgiet@giet.ac.in)

### List of students enrolled for A Two Week Certificate Program on Design and controlling of Humanoid Robots

S.NO	PIN NO	NAME OF THE STUDENT	PROGRAM NAME	YEAR-SEMETER	SIGNATURE OF STUDENT
1	17T91A0316	THOTA PAVAN BHASKAR	B.Tech-MECH	III-II	T. Pavan Bhaskar
2	18T91A0301	BALINA YUVA SAI SANTOSH	B.Tech-MECH	III-II	B. Yuva Sai Santosh
3	18T91A0302	ENNI MOHAN VAMSI	B.Tech-MECH	III-II	E. Mohan Vamsi
4	18T91A0303	GANDIKOTA SATYANANDAM	B.Tech-MECH	III-II	G. Satyanandam
5	18T91A0304	GANGISETTI T N V B MANI MAHESH	B.Tech-MECH	III-II	G. T. N. V. B. Mani Mahesh
6	18T91A0305	GARAGA VENKANNA BABU	B.Tech-MECH	III-II	G. Venkanna Babu
7	18T91A0306	KUNDRAPU MAHESH	B.Tech-MECH	III-II	K. Mahesh
8	18T91A0307	MADDIPATI BHANU KIRAN	B.Tech-MECH	III-II	M. Bhanu Kiran
9	18T91A0308	PILLA KIRAN KUMAR	B.Tech-MECH	III-II	P. Kiran Kumar
10	18T91A0309	PILLA SWAMI MANIKANTA	B.Tech-MECH	III-II	P. Swami Manikanta
11	18T91A0310	POLABATHULA VENKATESH	B.Tech-MECH	III-II	P. Venkatesh
12	18T91A0313	SANKHARAPU SAI KIRAN	B.Tech-MECH	III-II	S. Sai Kiran
13	18T91A0314	SETTI GOWTAM SAI VEERRAJU	B.Tech-MECH	III-II	S. Gowtham Sai Veerraju
14	18T91A0315	SUDDALA SAI GOPALA VAMSHI KRISHNA	B.Tech-MECH	III-II	S. Sai Gopal Vamshi Krishna
15	18T91A0316	ULLINGI DURGA VEERA PRASAD	B.Tech-MECH	III-II	U. Durga Veera Prasad
16	18T91A0318	VAKAPALLI WILLIAM ROBINS	B.Tech-MECH	III-II	V. William Robins
17	18T91A0319	PALA SAI AKHILESH	B.Tech-MECH	III-II	P. Sai Akhilesh
18	18T95A0313	JANGAM PHILIPS KIRAN BHASKAR	B.Tech-MECH	III-II	J. Philips Kiran Bhaskar
19	19T95A0301	BAIRI DEVI PRASAD	B.Tech-MECH	III-II	B. Devi Prasad
20	19T95A0302	BATHINA SRINIVAS	B.Tech-MECH	III-II	B. Srinivas
21	19T95A0303	BEJJIPARAPU RAMBABU	B.Tech-MECH	III-II	B. Rambabu
22	19T95A0304	BORRA SAI TEJA	B.Tech-MECH	III-II	B. Sai Teja
23	19T95A0305	CHITIKENA SUDHAKAR	B.Tech-MECH	III-II	C. Sudhakar
24	19T95A0306	EDURI RAJU	B.Tech-MECH	III-II	E. Raju
25	19T95A0307	GEDDAM ANAND PAUL	B.Tech-MECH	III-II	G. Anand Paul
26	19T95A0308	GIRAJALA SAGAR SWAMY	B.Tech-MECH	III-II	G. Sagar Swamy
27	19T95A0309	GURAJARAPU NARASIMHA MURTHY	B.Tech-MECH	III-II	G. Narasimha Murthy
28	19T95A0310	KANTIPUDI VIJNAN CHANDRA KALI PRASAD	B.Tech-MECH	III-II	K. V. Ch. Prasad
29	19T95A0311	KOLLI TARUN	B.Tech-MECH	III-II	K. Tarun
30	19T95A0312	PATNALA HARI KUMAR	B.Tech-MECH	III-II	P. Hari Kumar
31	19T95A0313	PILLA SATISH	B.Tech-MECH	III-II	P. Satish
32	19T95A0314	PYLA RAMKUMAR	B.Tech-MECH	III-II	P. Ramkumar
33	PIN NO	NAME OF THE STUDENT	PROGRAM NAME	YEAR-SEMETER	SIGNATURE OF STUDENT

33	19T95A0315	RONGALI MANIKANTA	B.Tech-MECH	III-II	B. Naidu
34	19T95A0316	SANGINIDI UDAY KIRAN	B.Tech-MECH	III-II	S. Uday Kiran
35	19T95A0317	SHAIK IBRAHEEM	B.Tech-MECH	III-II	S. Ibrahim
36	19T95A0318	THADI BALAJI	B.Tech-MECH	III-II	T. Balaji
37	19T95A0319	VAVILAPALLI SAIKUMAR	B.Tech-MECH	III-II	V. Saikumar
38	19T95A0320	KANDA AJAY SAI	B.Tech-MECH	III-II	K. Ajay Sai
39	19T95A0321	THOTAKURA CHANDRA SEKHAR	B.Tech-MECH	III-II	T. Chandra Sekhar
40	19T95A0322	ELURI SURYAVAMSI	B.Tech-MECH	III-II	E. Suryavamsi
41	19T95A0323	YESULANKA NAGA VENKATA SATYA VARA PR	B.Tech-MECH	III-II	Y. N. V. Satya Varaprasad
42	19T95A0324	MALICHETLA GOVINDA	B.Tech-MECH	III-II	M. Govinda
43	19T95A0325	PENDURTHI MANI VEERA KUMAR	B.Tech-MECH	III-II	P. Mani Veera Kumar
44	19T95A0326	PALLELLAMUDI JAYASYAM	B.Tech-MECH	III-II	P. Jayasym
45	19T95A0327	PIDUGU RAJA	B.Tech-MECH	III-II	P. Raja
46	19T95A0328	GONTHINA KIRAN	B.Tech-MECH	III-II	G. Kiran
47	19T95A0330	GUBBALA SATISH	B.Tech-MECH	III-II	G. Satish
48	19T95A0332	AVALA APPALAKONDA	B.Tech-MECH	III-II	A. Appalakonda
49	19T95A0333	BALLA MOHAN SIVA SAI KRISHNA	B.Tech-MECH	III-II	B. Mohan Sai Siva Krishna
50	19T95A0334	BEERAKA PAVAN KALYAN	B.Tech-MECH	III-II	B. Pavan Kalyan

V. Anish  
COORDINATOR

Principal  
GIET ENGINEERING COLLEGE,  
NH-16, Chaitanya Knowledge City,  
RAJAHMUNDRY - 533 296.

Anish  
HOD



Accredited by NAAC

### GIET ENGINEERING COLLEGE

NH-16, Chaitanya Knowledge City, GIET Campus, Rajamahendravaram, Andhra Pradesh-533296 Website: <http://www.gietec.ac.in> Email: [principalgiet@giet.ac.in](mailto:principalgiet@giet.ac.in)

#### DEPARTMENT OF MECHANICAL ENGINEERING

#### Day wise attendance

S.NO	PIN NO.	NAME OF THE STUDENT	24-02-2021	25-02-2021	26-02-2021	27-02-2021	01-03-2021	02-03-2021	03-03-2021	04-03-2021	05-03-2021	06-03-2021	08-03-2021	09-03-2021
1	17T91A0316	THOTA PAVAN BHASKAR	P	A	P	P	P	P	P	P	P	P	P	P
2	18T91A0301	BALINA YUVA SAI SANTOSH	P	P	P	P	A	P	P	P	P	P	P	P
3	18T91A0302	ENNI MOHAN VAMSI	P	P	A	P	P	P	P	P	P	P	P	P
4	18T91A0303	GANDIKOTA SATYANANDAM	P	P	P	P	P	P	P	A	P	P	P	P
5	18T91A0304	GANGISETTI T N V B MANI MAHESH	P	P	P	P	A	P	P	P	P	P	P	P
6	18T91A0305	GARAGA VENKANNA BABU	A	P	P	P	P	P	P	P	P	P	P	P
7	18T91A0306	KUNDRAPU MAHESH	P	P	P	P	P	P	P	P	P	A	P	P
8	18T91A0307	MADDIPATI BHANU KIRAN	P	P	P	A	P	P	P	P	P	P	P	P
9	18T91A0308	PILLA KIRAN KUMAR	P	P	P	P	P	P	P	P	A	P	P	P
10	18T91A0309	PILLA SWAMI MANIKANTA	A	P	P	P	P	P	P	P	P	P	P	P
11	18T91A0310	POLABATHULA VENKATESH	P	P	P	P	P	A	P	P	P	P	P	P
12	18T91A0313	SANKHARAPU SAI KIRAN	P	P	P	P	P	P	P	P	P	P	P	P
13	18T91A0314	SETTI GOWTAM SAI VEERRAJU	P	P	P	P	P	P	P	P	P	P	P	A
14	18T91A0315	SUDDALA SAI GOPALA VAMSHI	P	P	P	P	A	P	P	P	P	P	P	P
15	18T91A0316	ULLINGI DURGA VEERA PRASAD	P	P	P	P	P	P	A	P	P	P	P	P
16	18T91A0318	VAKAPALLI WILLIAM ROBINS	A	P	P	P	P	P	P	P	P	P	P	P
17	18T91A0319	PALA SAI AKHILESH	P	P	P	P	P	P	P	P	P	P	P	P
18	18T95A0313	JANGAM PHILIPS KIRAN BHASKAR	P	P	P	P	P	A	P	P	P	P	P	P
19	19T95A0301	BAIRI DEVI PRASAD	A	P	P	P	P	P	P	P	P	P	P	P
20	19T95A0302	BATHINA SRINIVAS	P	P	P	P	A	P	P	P	P	P	P	P
21	19T95A0303	BEJJIPARAPU RAMBABU	P	P	P	P	P	P	P	P	P	P	P	P
22	19T95A0304	BORRA SAI TEJA	P	P	P	P	P	P	P	A	P	P	P	P
23	19T95A0305	CHITIKENA SUDHAKAR	A	P	P	P	P	P	P	P	P	P	P	P
24	19T95A0306	EDURI RAJU	P	A	P	P	P	P	P	P	P	P	P	P
25	19T95A0307	GEDDAM ANAND PAUL	P	P	P	P	P	A	P	P	P	P	P	P
26	19T95A0308	GIRAJALA SAGAR SWAMY	P	P	P	P	P	P	P	P	P	P	P	P
27	19T95A0309	GURAJARAPU NARASIMHA MURTHY	P	A	P	P	P	P	P	P	P	P	P	P
28	19T95A0310	KANTIPUDI VIJNAN CHANDRA KALI PRASAD	P	P	P	P	P	P	P	A	P	P	P	P
29	19T95A0311	KOLLI TARUN	P	P	P	P	P	P	P	P	P	P	P	P
30	19T95A0312	PATNALA HARI KUMAR	P	A	P	P	P	P	P	P	P	P	P	P
31	19T95A0313	PILLA SATISH	P	P	P	P	P	A	P	P	P	P	P	P
32	19T95A0314	PYLA RAMKUMAR	P	P	P	P	P	P	P	P	P	P	A	P

20-21 - 3<sup>rd</sup> day

Principal  
 GIET ENGINEERING COLLEGE  
 NH-16, Chaitanya Knowledge City  
 RAJAHMUNDRY-533 296.

S.NO	PIN NG	NAME OF THE STUDENT	24-02-2021	25-02-2021	26-02-2021	27-02-2021	01-03-2021	02-03-2021	03-03-2021	04-03-2021	05-03-2021	06-03-2021	08-03-2021	09-03-2021
33	19T95A0315	RONGALI MANIKANTA	A	P	P	P	P	P	P	P	P	P	P	P
34	19T95A0316	SANGINIDI UDAY KIRAN	P	P	A	P	P	P	P	P	P	P	P	P
35	19T95A0317	SHAIK IBRAHEEM	P	P	P	P	P	P	P	A	P	P	P	P
36	19T95A0318	THADI BALAJI	P	P	P	A	P	P	P	P	P	P	P	P
37	19T95A0319	VAVILAPALLI SAIKUMAR	P	P	P	P	P	P	A	P	P	P	P	P
38	19T95A0320	KANDA AJAY SAI	P	P	P	P	P	P	P	P	P	P	P	P
39	19T95A0321	THOTAKURA CHANDRA SEKHA	P	P	P	P	A	P	P	P	P	P	P	P
40	19T95A0322	ELURI SURYAVAMSI	P	A	P	P	P	P	P	P	P	P	P	P
41	19T95A0323	YESULANKA NAGA VENKATA SATYA VARA PRASAD	P	P	P	P	P	P	P	P	A	P	P	P
42	19T95A0324	MALICHETLA GOVINDA	P	P	P	A	P	P	P	P	P	P	P	P
43	19T95A0325	PENDURTHI MANI VEERA KUMAR	P	P	P	P	P	P	A	P	P	P	P	P
44	19T95A0326	PALLELLAMUDI JAYASYAM	P	A	P	P	P	P	P	P	P	P	P	P
45	19T95A0327	PIDUGU RAJA	P	P	P	A	P	P	P	P	P	P	P	P
46	19T95A0328	GONTHINA KIRAN	P	P	P	P	P	P	P	P	A	P	P	P
47	19T95A0330	GUBBALA SATISH	P	P	P	P	P	P	A	P	P	P	P	P
48	19T95A0332	AVALA APPALAKONDA	P	P	P	P	P	P	P	P	P	P	P	A
49	19T95A0333	BALLA MOHAN SIVA SAI KRISHNA	P	P	P	P	A	P	P	P	P	P	P	P
50	19T95A0334	BEERAKA PAVAN KALYAN	P	P	P	P	P	P	P	A	P	P	P	P

V. Anidhan  
COORDINATOR

Principal  
GIET ENGINEERING COLLEGE,  
NH-16, Chaitanya Knowledge City,  
RAJAHMUNDRY - 533 296.

Sridhar  
HOD



## GIET ENGINEERING COLLEGE

NH - 16, Chaitanya Knowledge City, GIET Campus, Rajamahendravaram,  
Andhra Pradesh - 533296 Website: <http://www.gietec.ac.in> Email: [principalgec@giet.ac.in](mailto:principalgec@giet.ac.in)

---

Date:01.06.2022

### PROGRAM REPORT

**Name of the Program** : "Design and controlling of Humanoid Robots"

**Date/Duration** : 24.02.2021 to 09.03.2021 (Two Week).

**Resource Person** : Mr.K.V.G PRAVEEN,  
Assistant professor  
MECH, GIET ENGINEERING COLLEGE.  
Rajahmundry, A.P

Phone:8499063164

Mail:kvgpraveen107@gmail.com

**Name of the Coordinator** : Mr.V.AVINASH, Assistant Professor, MECH.

**No of the Participants** : 50

**Program Objective** :

- .To pursue understanding of the fundamentals of industrial robotics
- To understand the components of industrial robotics
- To grasp the various end effectors,efforts,sensors and actuators

**Topics Covered** :The following topics are covered

- Design and development of Robotics
- Sensing and Perception
- Robot decision making

  
Principal  
GIET ENGINEERING COLLEGE,  
NH-16, Chaitanya Knowledge City,  
RAJAHMUNDRY-533 296.



## GIET ENGINEERING COLLEGE

NH-16, Chaitanya Knowledge City, GIET Campus, Rajamahendravaram,  
Andhra Pradesh-533296 Website: <http://www.gietec.ac.in> Email: [principalgec@giet.ac.in](mailto:principalgec@giet.ac.in)

---

**Program Outcome :**

- Describe how sensors, microcontrollers and servo motor function implemented
- Select industrial robots, sensors and actuators based on application specification
- Determine the key parameters for designing and gripper

*V. Anish*  
**Coordinator**

*[Signature]*  
**Principal**  
**GIET ENGINEERING COLLEGE,**  
NH-16, Chaitanya Knowledge City,  
RAJAHMUNDRY - 533 296.

*[Signature]*  
**HOD**



# GIET ENGINEERING COLLEGE

Approved by AICTE, New Delhi/Affiliated to JNTUK, Kakinada/Accredited by NAAC  
NH-16, Chaitanya Knowledge City, GIET Campus, Rajamahendravaram-533296, AP, India.  
Phone: 96529 29111, Website: [www.gietec.ac.in](http://www.gietec.ac.in), Email: [principalgec@giet.ac.in](mailto:principalgec@giet.ac.in)

## CERTIFICATE

Certified that Mr./Ms. ENNI MOHAN NAMBI

bearing the PIN 18T91A0302 studying III B.Tech./MBA in the

department of MECHANICAL ENGG. has attended the add-on/certificate course on

DESIGN & CONTROLLING OF HUMANOID ROBOT from 24-02-2021 to

09-03-2021 during the academic year 2020-2021. He/She is advised to

maintain the same spirit in his/her future endeavors.

*V. Animesh*  
Coordinator

*Mishra*  
HOD

*Principal*  
Principal  
GIET ENGINEERING COLLEGE,  
NH-16, Chaitanya Knowledge City,  
RAJAHMUNDRY-533 296.

*Principal*  
Principal



# GIET ENGINEERING COLLEGE

Approved by AICTE, New Delhi/Affiliated to JNTUK, Kakinada/Accredited by NAAC  
NH-16, Chaitanya Knowledge City, GIET Campus, Rajamahendravaram-533296, AP, India.  
Phone: 96529 29111, Website: [www.gietec.ac.in](http://www.gietec.ac.in), Email: [principalgec@giet.ac.in](mailto:principalgec@giet.ac.in)

## CERTIFICATE

Certified that Mr./Ms. KUNDRAPU MAHESH

bearing the PIN 18791A0306 studying III B.Tech./MBA in the

department of MECHANICAL ENGR. has attended the add-on/certificate course on

DESIGN & CONTROLLING OF HUMANOID ROBOTS from 24-2-2021 to

09-03-2021 during the academic year 2020-2021. He/ She is advised to

maintain the same spirit in his/her future endeavors.

*V. Anirudh*  
Coordinator

*Sidhan*  
HOD

*Dev*  
Principal  
GIET ENGINEERING COLLEGE,  
NH-16, Chaitanya Knowledge City,  
RAJAMUNDRY-533 296.

*[Signature]*  
Principal





# GIET ENGINEERING COLLEGE

Approved by AICTE, New Delhi/Affiliated to JNTUK, Kakinada/Accredited by NAAC  
NH-16, Chaitanya Knowledge City, GIET Campus, Rajamahendravaram-533296, AP, India.  
Phone: 96529 29111, Website: [www.gietec.ac.in](http://www.gietec.ac.in), Email: [principalgec@giet.ac.in](mailto:principalgec@giet.ac.in)

## CERTIFICATE

Certified that Mr./Ms. POLABATHULA VENKATESH

bearing the PIN 18791A0310 studying III B.Tech./MBA in the

department of MECHANICAL ENGG. has attended the add-on/certificate course on

DESIGN & CONTROLLING OF HUMANOID ROBOTS from 24-02-2021 to

09-03-2021 during the academic year 2020-2021. He/She is advised to

maintain the same spirit in his/her future endeavors.

*V. Anish*  
Coordinator

*M. S. S.*  
HOD

*ew*  
Principal  
GIET ENGINEERING COLLEGE  
NH-16, Chaitanya Knowledge City,  
RAJAHMUNDRY-533 296.

*[Signature]*  
Principal



# GIET ENGINEERING COLLEGE

Approved by AICTE, New Delhi/Affiliated to JNTUK, Kakinada/Accredited by NAAC  
NH-16, Chaitanya Knowledge City, GIET Campus, Rajamahendravaram-533296, AP, India.  
Phone: 96529 29111, Website: [www.gietec.ac.in](http://www.gietec.ac.in), Email: [principalgec@giet.ac.in](mailto:principalgec@giet.ac.in)

## CERTIFICATE

Certified that Mr./Ms. SANKHARAPU SAI KIRAN

bearing the PIN 18791A0313 studying III B.Tech./MBA in the

department of MECHANICAL ENGG. has attended the add-on/certificate course on

DESIGN & CONTROLLING OF HUMANOID ROBOTS from 24-02-2021 to

09-03-2021 during the academic year 2020-2021. He/ She is advised to

maintain the same spirit in his/her future endeavors.

*V. Anish*  
Coordinator

*M. Han*  
HOD

*[Signature]*  
Principal  
GIET ENGINEERING COLLEGE,  
NH-16, Chaitanya Knowledge City, Rajamahendravaram -  
RAJAHMUNDRY-533 296.



# GIET ENGINEERING COLLEGE

Approved by AICTE, New Delhi/Affiliated to JNTUK, Kakinada/Accredited by NAAC  
NH-16, Chaitanya Knowledge City, GIET Campus, Rajamahendravaram-533296, AP, India.  
Phone: 96529 29111, Website: [www.gietec.ac.in](http://www.gietec.ac.in), Email: [principalgec@giet.ac.in](mailto:principalgec@giet.ac.in)

## CERTIFICATE

Certified that Mr./Ms. BATHINA SRINIVAS

bearing the PIN 19795A0302 studying III B.Tech./MBA in the

department of MECHANICAL ENGG. has attended the add-on/certificate course on

DESIGN & CONTROLLING OF HUMANOID ROBOTS from 24-02-2021 to

09-03-2021 during the academic year 2020-2021. He/She is advised to

maintain the same spirit in his/her future endeavors.

*V. Anish*  
Coordinator

*Asitha*  
HOD

*lud*  
Principal  
GIET ENGINEERING COLLEGE  
NH-16, Chaitanya Knowledge City,  
RAJAHMUNDRY-533 296.

*[Signature]*  
Principal

## Organising Committee

### Chief Patron

Shri. KVV Satyanarayana Raju  
Chairman, Chaitanya Group

### Patrons

Shri. K. Sasi Kiran Varma  
Vice-chairman, Chaitanya Group  
Smt. K. V. V. Lakshmi  
Executive Director, Chaitanya Group

### Co-Patrons

Dr. D. L. N. Raju  
CEO, Chaitanya Group  
P. Subba Raju  
General Manager, GIET Institutions

### Chairperson

Dr.S. Suryanarayana Raju  
Principal, GIET Engineering College

### Convener

Dr. P.Subbarao,  
Head of the department,  
Department of Management Studies,  
Email: [mba.gec@giet.ac.in](mailto:mba.gec@giet.ac.in)

### Co-ordinator

Mr. R.Sai Pandu,,  
Assistant Professor,  
Department of Management Studies  
Mobile No: 9490887592  
Email id: [rsaipandu@giet.ac.in](mailto:rsaipandu@giet.ac.in)

## A Certificate Program on "Results-Based Management"

### REGISTRATION FORM

1. Name of the Participant:
2. Class:
3. Roll Number:
4. Academic Year: ..
5. Branch:
6. Phone Number:
7. Email ID:
8. Address for Communication:
9. Signature of Participant:
10. Signature of class teacher:
11. Remarks (if any)

Date:  
Station:

  
Principal  
GIET ENGINEERING COLLEGE,  
NH-16, Chaitanya Knowledge City,  
RAJAHMUNDRY-533 296.

HOD



## A Certificate Program on "Results-Based Management"

**01-03-2021 to 13-03-2021**



Organized  
by

DEPARTMENT OF  
MANAGEMENT STUDIES

**GIET ENGINEERING COLLEGE**

(Formerly Known as Chaitanya Institute of Engineering & Technology)  
Approved by AICTE | Affiliated to JNTUK, Kakinada | Accredited by NAAC

NH-16, Chaitanya Knowledge City, GIET  
Campus, Rajamahendravaram, AP.

### About the Institute

The college is located at Catania Nagar on NH-16 on the outskirts of Rajamahendravaram, in GIET campus. GIET Engineering College is an epitome of excellence in every aspect. Institute is Approved by AICTE and affiliated to JNTUK, Kakinada, Andhra Pradesh.

The Institute got accredited by NAAC. The institute offers undergraduate programs in diverse engineering streams. It features state-of-the-art facilities and a highly qualified and knowledgeable pool of staff members, apart from the prescribed course curriculum, the institute offers an entire educational experience with greater exposure of students advanced skill learning via existing centres of excellence. It has been a pioneer in adopting several pedagogic innovations for the benefit of students. The achievements of the students of this institution in academics as well as placements stand testimony to the fact.



### About the Department

The primary objectives of the management department are to examine the data, refute the logic, challenge the conventional wisdom, and rethink business and management, which are prerequisites for business leaders and managers.

The department uses a variety of teaching methods including the case study approach, LPA (Learn, Practice, and Apply), activity-based learning (ABL), industrial visits, guest lectures, seminars, business fests, community activities, and more. There are scheduled interactive sessions with business professionals and entrepreneurs where insights on the theoretical underpinnings of modern entrepreneurship and innovation as well as honed business experience are shared.

The quality teaching and guidance by highly experienced faculty members provide the best quality educational experience to the students. The regular interaction between students and faculty helps a student to apply theoretical knowledge to real-life situations. Moreover, the faculty members organize special sessions for students; can help the aspirers to become a successful entrepreneur and corporate leaders of the business.

### About the Program



Results-based management is a tool for monitoring and managing the implementation of strategy. It in many respects is similar to the logical framework approach, a strategy implementation tool used extensively by Non-governmental organizations.

The main objective of the program is to increase transparency and accountability, allowing interventions to complement each other and avoid overlap and waste. At the end of the programme the student can understand need for RBM and Identifying customer perspectives, Internal perspectives and learning and innovation perspectives, Build risky information into RBM.

#### Resource Person

**Mr.E.T. Chakrapani,**  
Assistant Professor,  
Department of Civil Engineering,  
GIET Engineering College  
Rajahmundry.  
Mobile No: 9866878484  
Email id: [civil.gec@giet.ac.in](mailto:civil.gec@giet.ac.in)



## GIET ENGINEERING COLLEGE

NH - 16, Chaitanya Knowledge City, GIET Campus, Rajamahendravaram,  
Andhra Pradesh - 533296 Website: <http://www.gietec.ac.in> Email: [principalgect@giet.ac.in](mailto:principalgect@giet.ac.in)

### LIST OF REGISTERED STUDENTS

**Name of the Program: "A Certificate Program on Results-Based Management"**

**Duration: 01-03-2021 to 13-03-2021 (Two weeks)**

**A.Y: 2020-2021**

Sl. No	PIN Number	Name of the Student	Department/ Year	Student Signature
1	19T91E0001	AGASTHYA HEMANTH	II MBA	Hemant
2	19T91E0002	ASHIYA PATHAN	II MBA	Pathan
3	19T91E0003	CHADALAWADA GIFFI	II MBA	Giffi
4	19T91E0004	CHITALAPATI SAI DURGA PRASAD	II MBA	Durgaprasad
5	19T91E0005	DAYAM JYOTHSNA	II MBA	Jyothsna
6	19T91E0006	DUVVALAVANYA	II MBA	Alavanya
7	19T91E0007	GADDE VEERA VENKATA RAMA RAO	II MBA	G. Ramarao
8	19T91E0008	GORANTLA ASHOK KUMAR	II MBA	G. Ashok Kumar
9	19T91E0009	KANDASANI SAIDEEP	II MBA	Saideep
10	19T91E0010	KARAGANI GEETHA SRAVANI	II MBA	Geetha
11	19T91E0011	KATA MEENAKSHI	II MBA	K. Meenakshi
12	19T91E0012	MADDURI ARUDRA	II MBA	Arudra
13	19T91E0013	MAKIREDDI LOVARAJU	II MBA	Lovaraju
14	19T91E0014	MEDA MOHAN VINAY KUMAR	II MBA	Mohan
15	19T91E0015	NAMABATTULA SIRISHA	II MBA	N. Sirisha

Principal  
GIET ENGINEERING COLLEGE,  
NH-16, Chaitanya Knowledge City,  
RAJAHMUNDRY-533 296.



## GIET ENGINEERING COLLEGE

NH-16, Chaitanya Knowledge City, GIET Campus, Rajamahendravaram,  
Andhra Pradesh-533296 Website: <http://www.gietec.ac.in> Email: [principalgec@giet.ac.in](mailto:principalgec@giet.ac.in)

Sl. No	PIN Number	Name of the Student	Department/ Year	Student Signature
16	19T91E0016	NIMMAGADDA KANTHISRI	II MBA	D. Kantlisri
17	19T91E0017	PALEPOGU MOSHE	II MBA	P. Moshe
18	19T91E0018	PARLA PREETHI EVANGELIN	II MBA	P. Evangelin
19	19T91E0019	PENUGONDA DINESH	II MBA	P. Dinesh
20	19T91E0020	SAKINALA VEERA VENKATA RAMANA	II MBA	S.V.V. Ramana
21	19T91E0021	SIRIKI SURYA VENKATA SUDHA DEVI	II MBA	S. Sudha Devi
22	19T91E0022	TEKI SAI MADHURI	II MBA	T.S. Madhuri
23	19T91E0023	UTA TATAJI	II MBA	U. Tataji
24	19T91E0024	VANGA DIVYA	II MBA	V. Divya
25	19T91E0025	YELETI VISWA SARAN	II MBA	Y. Viswa Saran

  
Coordinator

  
Principal  
GIET ENGINEERING COLLEGE,  
NH-16, Chaitanya Knowledge City,  
RAJAHMUNDRY - 533 296.

  
HOD



# GIET ENGINEERING COLLEGE

NH - 16, Chaitanya Knowledge City, GIET Campus, Rajamahendravaram,  
Andhra Pradesh - 533296 Website: <http://www.gietec.ac.in> Email: [principalgec@giet.ac.in](mailto:principalgec@giet.ac.in)

## Day-wise Attendance Sheet

Name of the Program: "A Certificate Program on Contemporary Management Techniques in Strategic Planning"

Academic Year: 2020-21

Sl No	PIN Number	Day 1	Day 2	Day 3	Day 4	Day 5	Day 6	Day 7	Day 8	Day 9	Day 10	Day 11	Day 12
1	19T91E0001	P	P	P	P	P	P	P	P	P	P	P	P
2	19T91E0002	P	P	P	P	P	P	P	P	P	P	P	P
3	19T91E0003	P	P	P	P	P	P	A	P	P	P	P	P
4	19T91E0004	P	P	P	P	P	P	P	P	P	P	P	P
5	19T91E0005	P	P	P	P	P	P	P	P	P	P	P	P
6	19T91E0006	P	P	A	P	P	P	P	P	P	P	P	P
7	19T91E0007	P	P	P	P	P	P	P	P	P	P	P	P
8	19T91E0008	P	P	P	P	P	P	D	P	P	P	A	P
9	19T91E0009	P	P	P	P	A	P	P	P	P	A	P	P
10	19T91E0010	P	P	P	P	P	P	P	P	P	P	P	P
11	19T91E0011	P	P	P	P	P	P	P	P	P	P	A	P
12	19T91E0012	P	P	P	P	P	P	P	P	P	P	P	P
13	19T91E0013	P	P	P	P	P	P	P	P	P	P	P	P
14	19T91E0014	P	P	P	P	P	P	P	P	P	P	P	P
15	19T91E0015	P	A	P	A	P	P	P	P	P	P	P	P
16	19T91E0016	P	P	P	P	P	P	P	P	P	P	P	P
17	19T91E0017	P	P	P	P	P	P	P	P	P	P	P	P
18	19T91E0018	P	P	P	P	P	P	P	P	P	P	A	P
19	19T91E0019	P	P	P	P	P	P	P	P	P	P	P	P
20	19T91E0020	P	P	P	P	P	A	P	P	P	P	P	P
21	19T91E0021	P	P	P	P	P	P	P	P	P	P	P	P
22	19T91E0022	P	P	P	P	P	P	P	P	P	P	P	P
23	19T91E0023	P	P	P	P	P	P	P	P	P	P	P	P
24	19T91E0024	P	P	P	P	P	P	P	P	P	P	P	P
25	19T91E0025	P	P	P	P	P	P	P	P	P	P	P	P

Present: P, Absent: A

  
Coordinator

  
Principal  
GIET ENGINEERING COLLEGE,  
NH-16, Chaitanya Knowledge City,  
RAJAHMUNDRY - 533 296.

  
HOD





Accredited by NAAC

# GIET ENGINEERING COLLEGE

NH - 16, Chaitanya Knowledge City, GIET Campus, Rajamahendravaram,  
Andhra Pradesh - 533296 Website: <http://www.gietec.ac.in> Email: [principalgec@giet.ac.in](mailto:principalgec@giet.ac.in)

Date: 15-03-2021

## PROGRAM REPORT

**Name of the Program** : "A Certificate Program on Results-Based Management"

**Date/Duration** : 01-03-2021 to 13-03-2021 (Two Week).

**Resource Person** : Mr.E.T. Chakrapani, Assistant Professor,  
Department of Civil Engineering,  
GIET Engineering College  
Phone:9866878484  
Mail:civil.gec@giet.ac.in

**Name of the Coordinator** : Mr,R.Sai Pandu, Assistant Professor, Dept. of MBA

**No of the Participants** : 25

### Program Objectives

- Understand what RBM is and is not
- Use RBM principles and processes
- Theory of change and strategic results framework
- To know the Risk registers
- To flow Integrated monitoring and evaluation
- To use of evidence from monitoring and evaluation in decision-making
- To prepare Meaningful reporting to key stakeholders.
- Put RBM into practice
- To Design, implement and monitor the RBM framework
- Master the principles and practices of risk management when applied to RBM

### Topics Covered

- Definitions and core concepts of RBM
- RBM Performance measures – leading and lagging
- Information systems/technology as support tools for RBM
- Quantifying the organization via RBM
- Recognizing that RBM is a communications system for organizational change
- Mutual critique of RBM KPIs developed
- Situational and Stakeholder analysis
- RBM skills and tools necessary for effective and efficient management
- Set targets for each indicator used to judge performance

  
Principal  
GIET ENGINEERING COLLEGE,  
NH-16, Chaitanya Knowledge City,  
RAJAHMUNDRY-533 296.



## GIET ENGINEERING COLLEGE

NH -16, Chaitanya Knowledge City, GIET Campus. Rajamahendravaram,  
Andhra Pradesh - 533296 Website: <http://www.gietec.ac.in> Email: [principalgec@giet.ac.in](mailto:principalgec@giet.ac.in)

### Program Outcomes

At the end of the day students able to

- Understand need for RBM, Elements of RBM and Role of RBM
- Identifying customer perspectives. internal perspectives and learning and innovation perspectives
- Checking for alignment of the operational drivers
- Allocating resources to support strategic intent recognized in RBM
- Build risky information into RBM
- Identifying risk, analysis of risk impact and mitigation strategies
- Develop systems to collect data on actual results
- Reduce the risks of carrying forth long projects that could lead to poor results.

  
Coordinator

  
Principal  
GIET ENGINEERING COLLEGE,  
NH-16, Chaitanya Knowledge City,  
RAJAHMUNDRY - 533 296.

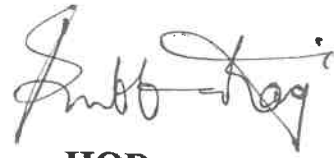
  
HOD



# GIET ENGINEERING COLLEGE

Approved by AICTE, New Delhi/Affiliated to JNTUK, Kakinada/Accredited by NAAC  
NH-16, Chaitanya Knowledge City, GIET Campus, Rajamahendravaram-533296, AP, India.  
Phone: 96529 29111, Website: [www.gietec.ac.in](http://www.gietec.ac.in), Email: [principalgec@giet.ac.in](mailto:principalgec@giet.ac.in)

## CERTIFICATE

Certified that Mr./Ms. Dayam Joyothisna

bearing the PIN 19T91F0005 studying 1 Year B.Tech./ MBA in the

department of Management Studies has attended the add-on/certificate course on

"Result Based Management" from 01/03/2021 to

13/03/2021 during the academic year 2020-21. He/ She is advised to

maintain the same spirit in his/her future endeavors.

*Rsan pte*  
Coordinator

*[Signature]*  
HOD

*[Signature]*  
Principal  
GIET ENGINEERING COLLEGE  
NH-16, Chaitanya Knowledge City,  
RAJAHMUNDRY-533 296.



# GIET ENGINEERING COLLEGE

Approved by AICTE, New Delhi/Affiliated to JNTUK, Kakinada/Accredited by NAAC  
NH-16, Chaitanya Knowledge City, GIET Campus, Rajamahendravaram-533296, AP, India.  
Phone: 96529 29111, Website: [www.gietec.ac.in](http://www.gietec.ac.in), Email: [principalgec@giet.ac.in](mailto:principalgec@giet.ac.in)

## CERTIFICATE

Certified that Mr./Ms. Gosantia Ashok Kumar

bearing the PIN 19791E0008 studying 1 year B.Tech./ MBA in the

department of Management Studies has attended the add-on/certificate course on

"Result Based Management" from 01/03/2021 to

13/03/2021 during the academic year 2020-21. He/ She is advised to

maintain the same spirit in his/her future endeavors.

R. S. S. S.  
Coordinator

[Signature]  
HOD

[Signature]  
Principal  
GIET ENGINEERING COLLEGE,  
NH-16, Chaitanya Knowledge City  
RAJAHMUNDRY-533 296. [Signature]  
Principal



# GIET ENGINEERING COLLEGE

Approved by AICTE, New Delhi/Affiliated to JNTUK, Kakinada/Accredited by NAAC  
NH-16, Chaitanya Knowledge City, GIET Campus, Rajamahendravaram-533296, AP, India.  
Phone: 96529 29111, Website: [www.gietec.ac.in](http://www.gietec.ac.in), Email: [principalgec@giet.ac.in](mailto:principalgec@giet.ac.in)

## CERTIFICATE

Certified that ~~Mr./Ms.~~ Madduxi Arudra

bearing the PIN 19791E0012 studying 6 year B.Tech./ MBA in the

department of Management Studies has attended the add-on/certificate course on

"Result Based Management" from 01/03/2021 to

13/03/2021 during the academic year 2020-21. He/ She is advised to

maintain the same spirit in his/her future endeavors.

Rsan Plee  
Coordinator

[Signature]  
HOD

[Signature]  
Principal  
GIET ENGINEERING COLLEGE  
NH-16, Chaitanya Knowledge City,  
RAJAHMUNDRY-533 296.

[Signature]  
Principal



# GIET ENGINEERING COLLEGE

Approved by AICTE, New Delhi/Affiliated to JNTUK, Kakinada/Accredited by NAAC  
NH-16, Chaitanya Knowledge City, GIET Campus, Rajamahendravaram-533296, AP, India.  
Phone: 96529 29111, Website: [www.gietec.ac.in](http://www.gietec.ac.in), Email: [principalgec@giet.ac.in](mailto:principalgec@giet.ac.in)

## CERTIFICATE

Certified that Mr./Ms. Meda Vinay Kumar

bearing the PIN 19791E0014 studying II year B.Tech./ MBA in the

department of Management Studies has attended the add-on/certificate course on

"Result Based Management" from 01/03/2021 to

13/03/2021 during the academic year 2020-21. He/ She is advised to

maintain the same spirit in his/her future endeavors.

  
Coordinator

  
HOD

  
Principal  
GIET ENGINEERING COLLEGE  
NH-16, Chaitanya Knowledge City,  
RAJAHMUNDRY-533 296.



# GIET ENGINEERING COLLEGE

Approved by AICTE, New Delhi/Affiliated to JNTUK, Kakinada/Accredited by NAAC  
NH-16, Chaitanya Knowledge City, GIET Campus, Rajamahendravaram-533296, AP, India.  
Phone: 96529 29111, Website: [www.gietec.ac.in](http://www.gietec.ac.in), Email: [principalgec@giet.ac.in](mailto:principalgec@giet.ac.in)

## CERTIFICATE

Certified that Mr./Ms. Namabttula sixisha

bearing the PIN 19791E0015 studying 11 year B.Tech./ MBA in the

department of Management studies has attended the add-on/certificate course on

"Result Based Management" from 01/03/2021 to

13/03/2021 during the academic year 2020-21. He/ She is advised to

maintain the same spirit in his/her future endeavors.

  
Coordinator

  
HOD

  
Principal  
GIET ENGINEERING COLLEGE,  
NH-16, Chaitanya Knowledge City,  
RAJAHMUNDRY-533 296.

  
Principal